

past | present | future

ACS



Jacobs



**Cork Line Level Crossings Project –
XC215 Shinanagh, Co. Cork
Targeted Archaeological Test Excavations**

ARCHAEOLOGICAL
CONSULTANCY
SERVICES UNIT



Prepared for Iarnród Éireann by Ian Russell

Licence No.: 20E639&20R248

18th December 2020

HEAD OFFICE

Unit 21

Boyne Business Park

Greenhills, Drogheda

Co. Louth

Tel: 041 9883396

PROJECT DETAILS

Project Details	Cork Line Level Crossings Project: Targeted Archaeological Test Excavations at XC215 Shinanagh
Site Name	XC215 Shinanagh, Co. Cork
Licence Number	20E639 & 20R248
Townland(s)	Ballynageragh & Imphrick
Parish	Imphrick
County	Cork
ITM	553605, 615358 (N) to 553465, 614494 (S)
RMP	CO007-120002-, CO007-120001-
RPS	None
Consultant	Archaeological Consultancy Services Unit, Unit 21 Boyne Business Park, Greenhills, Drogheda, Co. Louth
Iarnród Éireann Project Archaeologist	Jonathan Dempsey, Jacobs
ACSU Project Manager	Donald Murphy
Excavation Director	Ian Russell
Site Type	Environs of church and graveyard
Report by	Ian Russell and Magda Lyne
Report Status	Final
Report Date	18 th December 2020
ACS Ref.	2058

Contents

1. INTRODUCTION..... 1

 1.1 Scheme location and description 1

 1.2 Archaeological Potential 1

 1.3 Geophysical Survey..... 1

2. ENVIRONMENTAL AND HISTORIC CONTEXT 2

 2.1 Topography, soils, geology & hydrology 2

 2.2 Historical background..... 2

 2.3 Recorded Monuments and Places and Topographical Files..... 5

 2.4 Protected Structures 7

 2.5 Previous Archaeological Investigations..... 7

 2.5.1 Previous Investigations within the site 7

3. ADVANCE TARGETED ARCHAEOLOGICAL TEST EXCAVATIONS 8

 3.1 Aims & Objectives 8

 3.2 Methodology 9

 3.2.1 Survey, Excavation and Recording 9

 3.2.2 Finds Retrieval and Sampling Strategies..... 9

 3.2.3 Conditions 10

 3.2.4 Constraints on Methods 10

 3.3 Specialist Contributions and / or Consultations 10

 3.3.1 Artefacts 10

 3.3.2 Human remains 10

 3.3.3 Palaeo-environmental remains 10

 3.3.4 Metallurgical waste 10

4. ARCHAEOLOGICAL EXCAVATION RESULTS 11

 4.1 Field 1 11

 4.1.1 Pits 12

 4.1.2 Postholes 13

 4.1.3 Stakeholes 13

 4.1.4 Ditches 13

 4.1.5 Furrows 14

 4.2 Field 2 14

 4.2.1 Ditches 15

 4.2.2 Pit 17

 4.2.3 Spreads 17

 4.3 Field 3 17

 4.3.1 Ditches 18

4.3.2 Spreads	20
5. ARTEFACT CATALOGUE	20
6. SAMPLE REGISTER	20
7. DISCUSSION	20
8. POST-EXCAVATION PROPOSAL	21
8.1 Artefacts	21
8.2 Palaeo-environmental remains	22
8.3 Radiocarbon Dating Proposal	22
9. RECOMMENDATIONS	22
9.1. Further Work	22
10. INVENTORY OF FEATURES	24
11. BIBLIOGRAPHY	40
12. EXCAVATIONS BULLETIN	42

List of Tables

Table 1:	Recorded Monuments in the environs of the site
Table 2:	Previous archaeological investigations within and in the environs of the site
Table 3:	Field 1 Test Excavation Results, Test Trenches 1-9
Table 4:	Details of post-holes in Test Trench 2
Table 5:	Field 2 Test Excavation Results, Test Trenches 10-15
Table 6:	Field 3 Test Excavation Results, Test Trenches 16-20
Table 7:	List of samples
Table 8:	Radiocarbon Dating Proposal
Table 9:	Inventory of features

List of Figures

Figure 1:	Location of site
Figure 2:	Location of site, previous archaeological investigations and nearby Sites and Monuments Record sites
Figure 3:	Extract from 1st edition Ordnance Survey (OS) 6-inch map (surveyed 1840 - published 1844), showing location of site
Figure 4:	Extract from 3rd edition Ordnance Survey (OS) 25-inch map (surveyed 1903 - published 1905), showing location of site
Figure 5:	Aerial view of site, showing geophysical survey results and location of excavated test trenches

- Figure 6: Aerial view of site, showing geophysical survey results and location of excavated test trenches
- Figure 7: Details of Test Trenches 1 and 4
- Figure 8: Detail of Test Trench 2
- Figure 9: Detail of Test Trench 3
- Figure 10: Detail of Test Trenches 5 and 6
- Figure 11: Detail of Test Trench 9
- Figure 12: Detail of Test Trenches 10 and 11
- Figure 13: Detail of Test Trenches 12 and 13
- Figure 14: Detail of Test Trench 14
- Figure 15: Detail of Test Trench 15
- Figure 16: Detail of Test Trench 16
- Figure 17: Detail of Test Trench 17
- Figure 18: Detail of Test Trench 18 and 19
- Figure 19: Detail of Test Trench 20
- Figure 20: Sections of archaeological features uncovered in Test Trenches 1, 2, 3, 4 and 13
- Figure 21: Sections of archaeological features uncovered in Test Trenches 14, 15 and 16
- Figure 22: Sections of archaeological features uncovered in Test Trenches 16, 17 and 20
- Figure 23: Uncovered archaeology overlaying extract from 1st edition Ordnance Survey (OS) 6-inch map (surveyed 1840 - published 1844)
- Figure 24: Uncovered archaeology overlaying extract from 1st edition Ordnance Survey (OS) 6-inch map (surveyed 1840 - published 1844)
- Figure 25: Uncovered archaeology overlaying multi-hillshading image

List of Plates

- Plate 1: Test Trench 1, facing northwest
- Plate 2: Test Trench 1, following removal of C95, showing C53, C52, facing east
- Plate 3: Test Trench 1, pit C52, facing southwest
- Plate 4: Test Trench 1, pit C52, facing southwest
- Plate 5: Test Trench 2, facing southeast
- Plate 6: Test Trench 2, facing southeast
- Plate 7: Test Trench 2, ditch C25, facing northwest

Plate 8:	Test Trench 2, ditch C25, facing northeast
Plate 9:	Test Trench 3, ditch C4, facing northeast
Plate 10:	Test Trench 3, ditch C4, facing northeast
Plate 11:	Test Trench 4, facing northwest
Plate 12:	Test Trench 4, ditch C5, facing west
Plate 13:	Test Trench 4, ditch C5, facing northwest
Plate 14:	Test Trench 5, facing northwest
Plate 15:	Test Trench 5, ditch C56, facing northwest
Plate 16:	Test Trench 6, facing northeast
Plate 17:	Test Trench 6, ditch C57, facing southwest
Plate 18:	Test Trench 6, pit C58 facing northwest
Plate 19:	Test Trench 7, facing northeast
Plate 20:	Test Trench 8, facing northeast
Plate 21:	Test Trench 9, facing northeast
Plate 22:	Test Trench 9, ditch C3, facing east
Plate 23:	Test Trench 10, facing north
Plate 24:	Test Trench 10, ditch C64, facing west
Plate 25:	Test Trench 11, facing south
Plate 26:	Test Trench 11, ditch C63 facing southwest
Plate 27:	Test Trench 12, facing north
Plate 28:	Test Trench 12, ditch C80, facing west
Plate 29:	Test Trench 13, facing north
Plate 30:	Test Trench 13, ditch C74, facing east
Plate 31:	Test Trench 13, ditch C75, facing west
Plate 32:	Test Trench 14, ditch C67, facing northwest
Plate 33:	Test Trench 14, ditches C68, C69, facing southwest
Plate 34:	Test Trench 14, ditch C67 facing west
Plate 35:	Test Trench 14, spread C70 and linear C129, facing northeast
Plate 36:	Test Trench 15, C84-C86, facing southwest
Plate 37:	Test Trench 15, linear C87, spreads C88, C89, facing south

- Plate 38: Test Trench 15, ditch C85 and pit C84, facing north
- Plate 39: Test Trench 15, ditch C85, facing east
- Plate 40: Test Trench 15, pit C84, facing west
- Plate 41: Test Trench 16, facing northeast
- Plate 42: Test Trench 16, ditch C116, facing west
- Plate 43: Test Trench 16, ditch C112, facing west
- Plate 44: Test Trench 16, ditch C113, facing southeast
- Plate 45: Test Trench 16, ditch C115, facing west
- Plate 46: Test Trench 17, facing northeast
- Plate 47: Test Trench 17, ditch C121, facing north
- Plate 48: Test Trench 17, ditch C122, facing north
- Plate 49: Test Trench 18, ditch 107 facing southwest
- Plate 50: Test Trench 18, ditch C107, facing northeast
- Plate 51: Test Trench 18, ditch C108, facing southwest
- Plate 52: Test Trench 19, ditch C102, spread C103, facing north
- Plate 53: Test Trench 20, ditch C99, facing southwest
- Plate 54: Test Trench 20, ditch C99, facing northeast
- Plate 55: Test Trench 20, ditch C99, facing northwest
- Plate 56: Test Trench 20, ditch C98, facing southwest

EXECUTIVE SUMMARY

This report details the results of Advance Targeted Archaeological Test Excavations at XC215 Shinanagh, Co. Cork as part of the Cork Line Level Crossings Project. The site comprises three large open fields currently in use as pasture set in a landscape of undulating hills, in the townlands of Ballynageragh & Imphrick, civil parish of Imphrick and barony of Fermoy in County Cork.

The site is located in the immediate environs of three Recorded Monuments listed within the Record of Monuments and Places for County Cork (1998). These monuments consist of a Church (CO007-120002-) with an associated Graveyard (CO007-120001-) and Ritual site – holy well (CO007-121----). This parish church is probably late medieval in date (15th/16th century), would have been attached to the diocese of Cloyne and was reported as ‘in ruins’ in 1615. The SMR file notes that the Holmes family carried out some ‘improvements’ to the church in 1757 and an early 20th-century description mentions three different styles that can be observed in the structure of the church. This church may, however, be built on the foundations of an earlier church, as suggested by a listing in the Papal Taxation of 1291. It should be also mentioned that a Ritual site – holy well (CO007-121----), named Tobernadeecla, now located on the east side of the railway line, might be associated with the mentioned church and graveyard.

There are no Protected Structures located within the site as listed in the Cork County Council Development Plan 2013–2019 and no National Inventory of Architectural Heritage (NIAH) structures within or in the immediate environs of the site.

This programme of Advance Targeted Archaeological Test Excavation was based on the results of a geophysical (Fluxgate Gradiometer) survey undertaken as a component and in advance of the Cork Line Level Crossings Project (20R0016) carried out by Archaeological Management Solutions (AMS) in February 2020 and Target Archaeological Geophysics (Target) in June 2020. The Test Excavations Strategy was designed to assess the archaeological nature of anomalies detected during these surveys. The results of these test excavations will inform the Cork Line Level Crossings Project Environmental Impact Assessment Report (EIAR).

Ian Russell of ACSU undertook the test excavations under licence 20E639 between the 18th and 25th November 2020. A metal detector was used under licence 20R248 to scan all relevant archaeological and potential archaeological soils. A total of 20 test trenches were excavated targeting anomalies identified, using a 14 tonne tracked excavator fitted with a 1.8m wide toothless bucket. In total 317m of linear test trenches were excavated (Test Trenches 1-20). In general, the average thickness of the topsoil measured c. 0.3-0.6 m and consisted of greyish brown sandy clay exposing natural, that varied between greyish yellow sandy clay and pale orange grey marl.

Three areas of archaeological activity were identified; in the north end of Field 1; in the south end of Field 2, and; within Field 3. In the north extent of Field 1, a number of features of archaeological significance were exposed and comprised pits, post-holes, linears and ditches, all suggestive of settlement/archaeological activity within the site. While the fills of the features did not contain any datable finds, smithing slag was retrieved and samples were taken.

The features located in the south end of Field 2 were identified during geophysical survey, and targeted test trenching confirmed their archaeological significance. The features exposed consisted of linears, pits, ditches and charcoal spreads associated with metalworking with metallurgical waste material retrieved from both spreads and linears.

In Field 3 a spread and a number of linears/ditches were exposed. While these did not produce any datable material, their linear nature and sterile fills are suggestive of field systems of unknown date. Their location in the immediate environs of the Church (CO007-120002-); an associated Graveyard (CO007-120001-) and Ritual site – holy well (CO007-121----) indicates that these features may potentially be associated with the medieval landscape. A future, more extensive investigation is recommended to determine their full extent and significance.

It appears that most of the remaining linear features identified throughout the site are consistent with anomalies identified in geophysical survey and represent field divisions and/or former field boundaries as well as in some cases variations in the natural geology and/or changes in the topsoil, likely of recent date.

A number of environmental samples from the various features, including pit and ditch fills were taken on site. Some of these produced charcoal and it is recommended that a number of these be submitted for radiocarbon dating in order to better understand the nature and dating of the features exposed. As the proposed Cork Line Level Crossings Project will require significant ground works, all identified features will be directly impacted. Where preservation in situ is not feasible, full preservation by record (i.e. archaeological excavation) in advance of construction works commencing will therefore be required in order to mitigate this permanent impact. The possible presence of other smaller archaeological features along this route in the un-tested areas can not be dismissed; therefore it is recommended that the area is subject to more general test trenching throughout the full land take area in advance of construction works commencing. The particulars of any mitigation measures will be included in the Environmental Impact Assessment Report for the scheme.

ACKNOWLEDGEMENTS

This report was prepared by Archaeological Consultancy Services Unit for Jacobs on behalf of Iarnród Éireann. The excavation was carried out under Licence from the Minister of Culture, Heritage and the Gaeltacht, in consultation with the National Museum of Ireland (NMI).

Iarnród Éireann Infrastructure

Project Manager, New Works – James Kenny

Jacobs

Project Manager – Alex Bradley

Project Archaeologist – Jonathan Dempsey

National Monuments Service, Department of Culture, Heritage and the Gaeltacht

Archaeologist – Mairead Weaver

1. INTRODUCTION

This report details the results of Advance Targeted Archaeological Test Excavations at XC215 Shinanagh, Co. Cork as part of the Cork Line Level Crossings Project: (ITM 553605, 615358 (N) to 553465, 614494 (S); Figures 1–2).

This programme of testing was based on the results of a geophysical (Fluxgate Gradiometer) survey undertaken as a component and in advance of the Cork Line Level Crossings Project (20R0016, Dowling 2020; Nicholls 2020). The Test Excavations Strategy was designed to assess the archaeological nature of anomalies detected during these surveys.

The test trenching was carried out by one team working under the direction of Ian Russell of Archaeological Consultancy Services Unit Ltd (ACSU) under licence 20E0639 between the 18th and 25th November 2020. A metal detector was used under licence 20R248 to scan all potential archaeological soils.

1.1 Scheme location and description

The site at Ballynageragh & Imphrick townlands, Ballyhea, Co. Cork is located adjacent and north of Rail Crossing XC215 Shinanagh, to the west of the Dublin-Cork Railway Line between Limerick Junction and Mallow Station. It consists of parts of three large open fields currently in use as pasture set in undulating landscape, in the townlands of Ballynageragh & Imphrick, civil parish of Imphrick and barony of Fermoy in County Cork.

Iarnród Éireann is applying to An Bord Pleanála (ABP) for a Railway Order under the Transport (Railway Infrastructure) Act 2001 (as amended) to eliminate/upgrade seven public road level crossings on the Dublin-Cork Railway Line. The proposed development is Strategic Infrastructure Development (SID), and a pre-application consultation has taken place with ABP as well as statutory consultees, including the National Monuments Service (NMS).

The proposed works include an upgrade to the existing overbridge and a new road tie in to existing Local Road to the north.

1.2 Archaeological Potential

The site is located within the immediate environs of Recorded Monuments, consisting of a Church (CO007-120002-) with an associated Graveyard (CO007-120001-) and Ritual site – holy well (CO007-121----). The church and graveyard are located to the west of the proposed development while the holy well is located to the east, and on the other side of the railway line. These monuments are depicted on the first edition OS map of 1840, where the church and graveyard are depicted within an area delimited by the graveyard wall. This church may, however, be built on the foundations of an earlier church, as suggested by a listing in the Papal Taxation of 1291 and extend beyond the area delimited by the graveyard wall.

There are no Protected Structures on the site or in Ballynageragh & Imphrick townlands in the Cork County Council Development Plan 2013–2019 or structures listed within the National Inventory of Architectural Heritage (NIAH).

1.3 Geophysical Survey

Two phases of geophysical survey were undertaken on the scheme.

- The Phase 1 geophysical survey (20R0016, Dowling 2020) of Field 3 was undertaken by Archaeological Management Solutions (AMS) in February 2020. Field 3 is located within the southern extent of the site in the environs of the Church and Graveyard. This work resulted in the identification of a number of features, including three curving features (1–3) to the east and south of the existing churchyard enclosure which were considered at the time to comprise the remains of an early

ecclesiastical enclosure. In addition, linear and curvilinear anomalies (4–14) recorded across the survey area were considered at the time to reflect extensive multi-period activity, perhaps involving settlement and/or agriculture. Of more recent origin are the remains of two relict field boundaries (15 & 16) shown on both the first and second-edition OS maps (1844 and 1905 respectively).

- The second phase of geophysical survey (20R0016; Nicholls 2020) of Field 1 and 2 was undertaken by Target Archaeological Geophysics (Target) in June 2020. Field 1 is located in the north part of the site, while Field 2 is located adjacent and directly north of Field 3 surveyed during Phase 1. In Field 2 a concentration of linear anomalies, discrete positives and a large burnt/fired deposit (Target 15) in the southern portion of this field were considered to represent the remnants of a possible ecclesiastical settlement associated with the church and graveyard CO007-120001/002. Some of the anomalies correspond to surface visible earthworks noted at the time of fieldwork, and were thought likely to represent a continuation of the linear remains recorded from the phase 1 survey. The remaining anomalies highlight discrete positives and weak trends of uncertain origin, responses from former boundaries, some of which correspond to historic mapping, localized variations in soil morphology/geology, and modern ferrous.

2. ENVIRONMENTAL AND HISTORIC CONTEXT

2.1 Topography, soils, geology & hydrology

The site is located in the townlands of Ballynageragh & Imphrick, to the southwest of Ballyhea village, to the west of the Mallow – Charleville railway line and west of the Ballyhoura Mountains. The site is c. 43 km south of the River Shannon and c. 47km northwest of Lough Mahon and Cork Harbour. The River Awbeg, a tributary of the River Blackwater, is located c. 0.7km to the west of the site.

The site has an elevation of c. 91-100 OD. The site itself is mostly flat with several linear and curvilinear depressions visible in Fields 2 and 3. The underlying geology of yellow & red sandstone & green mudstone is a part of the Kiltorcan Formation; this formation comprises coarse-grained white-yellow sandstone, mudflake conglomerate, red-yellow flaggy sandstone, green silty mudstone and green mudstone. The underlying sandstone and mud stone, is covered by deep well drained mineral mainly acidic soils (Geological Survey of Ireland).

2.2 Historical background

The site lies within two townlands; the northern extent is located in the eastern part of Ballynageragh townland, whereas the southern part is located in the townland of Imphrick. The site is located in the Barony of Fermoy and Civil Parish of Imphrick. An examination of the Placenames Database of Ireland (www.logainm.ie) can reveal important information about the natural and cultural heritage of an area. For example Ballynageragh (Irish: Baile na gCarrach) was first mentioned in 1573 as Ballynygaragh. Imphrick (Irish: Imfric) was first mentioned in 1301 as 'Yncchiyk' and the later deviation of its name, 'Emerick', is mentioned in relation to a Parish in Fermoy Barony and labelled on the Down Survey Map of 1654–56.

There are two Recorded Monuments located within the townland of Ballynageragh (see Figure 2). These consist of a 'Castle – unclassified (CO007-119001-)', known as Rathmore Castle, that was destroyed in the 17th century. The other monument is classed as 'Excavation – miscellaneous (CO007-119002-)' and represents an occupation site, possibly related to Rathmore Castle. The site was discovered in 1986 during construction of the Bruff–Mallow gas pipeline.

The townland of Imphrick contains three recorded monuments, a 'Church (CO007-120002-)' and associated with it a 'Graveyard (CO007-120001-)' and a 'Ritual site – holy well (CO007-121----)'. This parish church is probably late medieval in date (15th/16th century), would

have been attached to the diocese of Cloyne and was reported as 'in ruins' in 1615 (Power et al. 2000, 552, 561). It may, however, be built on the foundation of an earlier church, as suggested by a listing in the Papal Taxation of 1291 (ibid., 561). The associated graveyard is enclosed by a low earthen bank but is densely overgrown, with the earliest recorded monument a vault dated 1757 (ibid., 584). The holy well, now located on the opposite side of the railway track, is north-east of the church site and depicted as Tobernadeecla (St Declan's Well) on the first edition 6-inch OS map of 1844 (surveyed 1840) and the 25-inch OS map of 1905 (surveyed 1903). Locally this is known to cure sore eyes with a feast day on 24 July (<https://holywellsorkandkerry.com/gazeteer/>). The worship of holy wells is hard to date. It likely originates around the 7th century AD but some wells also retain pre-Christian characteristics, like the ones near Tara in County Meath. The springs of prehistory were likely transformed to Holy Wells with the introduction of Christianity, as part of a gradual process of transformation from paganism to Christianity. Wells often took their name after a saint, with St Patrick or St Brigid being most common, while here its Tobernadeecla or St Declan's Well. Holy wells can be found in isolation but are also often found in the proximity of early church sites (O'Sullivan & Downey 2006).

General Background

Earlier prehistoric period (c. 8000–2200 BC)

County Cork was subject to human settlement since Mesolithic times (c. 8000–4000 BC) when early hunter-gatherer communities would have exploited the rivers, lakes and other natural resources around them. As there are no monuments associated with the Mesolithic period, and associated settlement sites can be difficult to locate in the landscape, establishing a detailed picture of the lifestyle of these Mesolithic people must often rely on scatters of diagnostic stone tools. At Kilcummer, Co. Cork, for example, the discovery of a scatter of microliths, overlooking the junction of the Rivers Blackwater and Awbeg, suggests an Early Mesolithic presence, although subsequent excavation did not reveal any significant in situ deposits (Woodman 2015, 205–6).

The Neolithic period (c. 4000–2500 BC) saw the gradual spread of farming throughout Europe, which appears to have also brought with it the custom of communal burial in great stone structures known as megalithic tombs. The cultivation of crops and the husbandry of livestock brought necessary changes in the lifestyle of the people, including the development of more long-term dwellings and extensive woodland clearances for farmland; the remains of a possible Neolithic house (CO016-318001-) were excavated in 1986 during the construction of the Bruff–Mallow gas pipeline (Gowen 1988, 44–51).

Stone circles, stone alignments and standing stones were also markers of important locations during the early prehistoric period and there are several standing stones recorded in the surrounding townlands, including Curraghcloonabro East (CO002-085----); Rathgoggan South (CO003-020----); Lisballyhay (CO008-071----); Walshestown (CO016-075001-); Bregoge (CO016-208----); Velvetstown (CO017-006002-); Kilcolman East (CO017-023----); Ballyellis (CO017-034----); Spital (CO017-118----); Rathclare (CO017-120---- and CO017-126----) and Ballynaboola (CO008-012002-). Many of these may date to the later Neolithic to earlier Bronze Age and are long understood to mark important places, including burials, boundaries and routeways. At Ballynaboola, for example, the standing stone was dislodged during forestry operations in the proximity to a cluster of three cist burials (CO008-012001-, 003- and 004-) containing cremated bones, although its original location is not known. That at Walshestown was nearly 10 m west of a burial ground (CO016-075002-) and that at Velvetstown was c. 50 m north-east of a possible earthwork (CO017-006001-).

Later prehistoric period (c. 2200 BC–AD 400)

From the beginning of the Bronze Age (c. 2200–800 BC), inhumation and cremation burials were deposited in pits and stone-lined cists. Many of these burials were accompanied by food vessels and urns, and sometimes copper, bronze or worked stone objects. These

sites are often represented by a single grave with no above-ground markers, but others were placed in mounds or barrows. At Rathgoggan South, a possible pit burial was discovered in 1986 during the construction of the Bruff–Mallow gas pipeline, comprising an oval pit filled with abundant charcoal and flecks of burnt bone (Gowen 1988, 179). As mentioned above, three cists were uncovered at Ballynaboola, north-west of Newtown, and although little information survives they appear to have contained cremated bone and may date to this period. A series of barrow monuments are also recorded in the surrounding townlands, including Gortskagh (CO002-016---); Ardnageehy (CO007-052----); Castlewrixon South (CO008-028---- and CO008-032----); Garrane (CO008-062----, -063---- and -064---) and Kilcolman West (CO017-037002-). Notably, the cluster of barrows at Garrane is just north of the three Ballynaboola cists. Several mounds and ring-ditches are also recorded in the area, some of which may also represent barrow monuments. While these monument types frequently date to the Bronze Age, barrow monuments also continued into the Iron Age (c. 800 BC–AD 400).

Burnt mounds (also known as *fulachtaí fia*) comprise the most commonly discovered evidence for prehistoric settlement across Ireland and represent the use of pyrolithic technology to boil water, with those noted close to a trough generally interpreted as cooking/industrial sites (Hawkes 2018). They generally consist of a low mound of charcoal-enriched soil mixed with an abundance of heat-shattered stones, commonly forming a horseshoe shape in proximity to a trough, and are found in low-lying marshy areas or close to streams, springs and other water sources. Often these sites have been ploughed out and survive as a spread of heat-shattered stones with no surface expression. Analysis of these sites indicates that the tradition originated in the Early Neolithic and continued intermittently until sometime on the mid-first millennium BC, with a concentration of use in the Middle and Late Bronze Age (*ibid.*, 115). A large number of burnt mounds are recorded in the surrounding townlands, including one (CO008-061----) directly beside the Garrane barrows and a cluster of six burnt mounds (CO017-037001-, 003-, 004-, 005-, 006-, 007-) surrounding the Kilcolman West barrow and another (CO008-031----) just south of one of the Castlewrixon South barrows. Many of these burnt mounds are known from on-site surveys, aerial photography and local information, but others have been excavated. Two examples at Rathgoggan South (CO003-015001- and 002-), just south-east of Charleville, and a further two sites at Shinanagh (CO007-131001- and 002-), comprised spreads of burnt mound material (Gowen 1988, 179). The latter two sites are directly west of the northern end of the site.

Iron Age occupation has traditionally been difficult to identify in Ireland but recent excavations and research has greatly increased the number of sites and finds across the country (see Corlett & Potterton 2012). Alongside burnt mounds, roundhouses, cereal-drying kilns, metalworking sites and burials in ring-ditches and flat graves have also been increasingly discovered.

Early Medieval (c. AD 400–1100)

It is suggested that from at least the fifth century AD, significant increases in population were brought about by new agricultural practices. Pollen records dated to this period suggest a huge upsurge in grasses and weeds associated with the development of pasture and arable farming (Aalen et al. 1997, 44). During this period, the development of new plough types and horizontal watermills were two innovations that would have provided farming communities with increased levels of agricultural production. This evidence for economic growth is best seen in the widespread distribution of early medieval (c. AD 400–1100) settlement sites, which occurred as dispersed defended homesteads on lakes (*crannógs*) and across the wider landscape as 'ringforts' or *raths* (O'Sullivan et al. 2013). A *rath* is generally defined by an earthen bank, formed by material thrown up from a fosse or ditch located immediately outside the bank. Comparable enclosures constructed of stone are referred to as *cashels*. Generally, *raths* vary in size from 25–50 m in diameter and are usually circular in plan but can also be oval or D-shaped. Some have more than one bank and ditch but such examples are rarer than the simpler or univallate type. *Raths* generally contain houses and ancillary buildings, with excavated examples revealing evidence for activities related to agriculture as well as small-scale craft and industry. Generally, the internal structures would have been made of perishable materials such as wood and straw, however, stone was also used, particularly in *cashels*. Rural settlement sites such as

these were also positioned within wider agricultural landscapes, with many recent excavations uncovering evidence for field systems related to cultivated crops and livestock management, as well as ancillary activities such as processing cereals and iron-working practices (see Corlett & Potterton 2011). To the far north-west of the site there is a Ringfort – rath (CO007-079----) in the townland of Shinanagh and to the south-east there is another Ringfort – rath (CO008-045----) in the townland of Lisballyhay, both of which are recorded as low earthen banks defining areas of c. 30–35 m in diameter. Nearby enclosures (CO007-158---- and CO008-044----) may also represent the remains of early medieval settlement sites.

Late Medieval (c. AD 1100–1600) to Post-Medieval (c. AD 1600–1800)

Charleville, from the Irish Ráth Luirc or An Ráth, would have been extensively occupied during the early medieval period due to the rich agricultural land in this area, known as the Golden Vale. The old name for the area, Rathcogan or Ráth an Ghogánaigh, is reputed to relate to Miles de Cogan, who was granted lands here in 1177 following the Norman invasion (Binchy 1962). During the Elizabethan Munster Plantation, the present town was founded and named Charleville under Royal Charter in 1671 (Flynn 2011, 5). With his residence subsequently burnt in 1690 by the Irish under the command of the Duke of Berwick.

Buttevant was similarly founded during the Anglo-Norman period, with the name representing a corruption of a French word for outpost (Flynn 2011, 5). On the southern side of Buttevant, overlooking the River Awbeg to the east, is the remains of a 13th-century Anglo-Norman masonry castle (CO017-054001-) built by the de Barrys, who were also granted a fair and market at Buttevant in 1234 (Power et al. 2000, 517). There are also several mottes and moated sites within the surrounding townlands, both suggesting the remains of Anglo-Norman sites built in the late 12th/early 13th century and the late 13th/early 14th century respectively.

Directly west of the site, in the townland of Ballynageragh, there is the site of a castle (CO007-119001-) situated on a north-facing slope 600 m north-east of the River Awbeg and known as Rathmore Castle. Although no surface trace remains it was reputedly a castle of the Roches that was destroyed in the 17th century (Power et al. 2000, 509). An excavation (CO007-119002-) directly to the east in 1986 uncovered a deposit of burnt stone, stake- and post-holes, pits, a sunken hearth and agricultural furrows/drains, a fragment of a rotary quern stone and corroded bronze and iron objects, all probably related to the use of the castle (Gowen 1988, 136–40).

The first railways were built in Ireland in the early 1880s, with the Great Southern & Western Railway (GS&WR) originally built to connect Dublin with Cashel but later extended to the city of Cork. Many of the associated railway stations and other buildings are an important part of the history of the railway in Ireland

2.3 Recorded Monuments and Places and Topographical Files

The site is located in the immediate environs of three Recorded Monuments listed within the Record of Monuments and Places for County Cork (1998). These monuments consist of a Church (CO007-120002-) within an associated Graveyard (CO007-120001-) and a Ritual site – holy well (CO007-121----). The site lies partially within the zone of notification for the church and graveyard.

No archaeological finds are listed within the Topographical Files of the National Museum of Ireland located within the site or in the townlands of Ballynageragh and Imphrick.

The following is a list of the nearest Recorded Monuments located within the surrounding area (Figure 2). These descriptions are derived from the published Archaeological Inventory of County Cork, Volume 4: North Cork (Power et al. 2000) but in certain instances, the entries may have been revised and updated in the light of recent research and are available in the National Monuments Service Archaeological Survey Database.

Table 1: Recorded Monuments in the environs of the site

RMP/SMR No	Class/ Site Type	Townland	Description
CO007-120002-	Church	Imphrick	In NW corner of graveyard. Ruin of rectangular church (int. greater than 17.3m E-W; int. 4.85m N-S), heavily ivy-clad. West gable with returns of N (int. L 8.3m) and S (int. L 8.3m) walls all that now stand. West gable crowned by bellcote (see photograph Grove White 1905–25, vol. 3, opp. 186). High up on gable is window with single flat-headed light high. Gap in N wall (Wth 1.4m), immediately E of W gable, may mark site of doorway. External projection at W end of S wall may be remains of annexe (church depicted on 1842 OS 6-inch map as irregular 'T-shaped' structure) or may mark buttress (see photograph, <i>ibid.</i>). Also in N wall is ruined doorway covered by segmental arch. Line of S wall continues to E of standing portion as overgrown rise; position of E gable probably marked by similar rise and burial vault, c. 9m E of standing portions of N and S walls. A 1906 account of church (<i>ibid.</i> , 186) describes 'three different styles...of architecture', two different in age but ancient, the third 'more recent improvements...executed by the Holmes family, whose monument [dated 1757]...is so conspicuous an object'. Adjoining and parallel to church on S side were 'the foundations and part of the walls of some structure...nearly 30 feet by about 12 feet...[which] appears to be quite as old as the main building itself' (<i>ibid.</i>). Remains of parish church of Imphrick. Reported 'in ruins' in 1615 (Brady 1863, vol. 2, 306). A church here listed in Papal Taxation of 1291 (<i>ibid.</i>).
CO007-120001-	Graveyard	Imphrick	In pasture, c. 100m N of road. Subrectangular graveyard (c. 40m E-W; c. 30m N-S), enclosed by low earthen bank. Ruin of parish church of Imphrick in NW corner. Much of graveyard densely overgrown; earliest headstone noted, inside N wall of church, dated 1783; recent burial near entrance to E. Grove White (1905–25, vol. 3, 186) noted monument to Holmes, dated 1757- may be overgrown vault at E end of church. Burials dated 1762 and 1790 have also been recorded (Grove White 1913–16, 241).
CO007-121----	Ritual site - holy well	Imphrick	Named 'Tobernadeecla' on 1842 OS 6-inch map. In small field on W side of road. Access to field by gate from road and to well area by stile. Rectangular well enclosed and partially covered by low stone surround. Votive offerings surround well and rags adorn over-hanging bush.
CO007-119002-	Excavation – misc.	Ballynageragh	Discovered in 1986 during construction of Bruff–Mallow gas pipeline (Gowen 1988, 136–40). Occupation site, possibly related to Rathmore Castle (14287) c. 90m to W. Excavated area (7.5m x 4m) produced 23 features. Largest feature was shallow depression (F23) (4.6m x max. 1.2m; D 0.5m); this was filled with large burnt stones overlaid by black soil, possibly burnt in situ; three groups of stake and small post-holes just inside SE edge. Arc of four shallow pits (F6, 8, 10, 14) to E and NE of F23. Feature F14 (1.85m x 1.5m; D 0.54m), vertical-sided and flat-based, contained some charcoal and burnt clay in fill; F8, immediately to NW, was a sunken hearth (1.8m x 1.5m; D 0.3m); F10 and F6 to NW (both 2.4m x 0.7m; D c. 0.2m) had clean uniform fills. Pits cut by at least three phases of linear features at varying alignments which were mostly interpreted as agricultural in origin. Finds included fragment of rotary quern, and corroded bronze and iron.
CO007-119001-	Castle - unclassified	Ballynageragh	On N-facing slope, c. 600m NE of Awbeg River. No visible surface trace of castle. According to local tradition (Grove White 1905–25, vol. 3, 186), 'stones of the old castle were used in building Castle Harrison house'. Castle of the Roches (Healy 1988, 305), reputedly destroyed in 17th century (<i>ibid.</i>).
CO007-131002-	Fulacht fia	Shinanagh	On low-lying, mostly level ground. Discovered during construction of Bruff–Mallow gas pipeline (Gowen 1988, 179). Spread of burnt material (L 14m; Wth 6-8m) adjacent to field fence which also contains burnt material. Low mound visible outside pipeline corridor to W. Second fulacht fiadh c. 17m to S.
CO007-131001-	Fulacht fia	Shinanagh	On low-lying, mostly level ground. Discovered during construction of Bruff–Mallow gas pipeline (Gowen 1988, 179). Semi-circular spread of burnt material (L 11.4m) extended 4m into pipeline corridor; main bulk of site, consisting of

RMP/SMR No	Class/ Site Type	Townland	Description
			low, ill-defined mound, lay outside pipeline corridor to W. Second fulacht fiadh c. 17m to N.

2.4 Protected Structures

The site contains no Protected Structures listed in the Cork County Development Plan 2013–2019, and there are no Protected Structures in the immediate environs of the site or structures listed within the National Inventory of Architectural Heritage (NIAH).

2.5 Previous Archaeological Investigations

An examination of previously excavated sites in the vicinity of the proposed development area indicates that several archaeological investigations have been conducted within the wider area, many of which did not reveal any archaeological remains, however investigations carried out in the vicinity and to the west of the site, undertaken in relation to the construction of the Bruff–Mallow gas pipeline, resulted in the discovery of three monuments – two fulacht fia (CO007-131001- and -02) and one Excavation – miscellaneous (CO007-119002-). Earlier this year, geophysical survey (20R0016) of the site took place in February and June 2020 and produced interesting results that are outlined below.

The details of previous archaeological investigations in the area, derived from the Summary Accounts of Archaeological Excavations in Ireland (www.excavations.ie), are also outlined below.

Table 2: Previous archaeological investigations within and in the environs of the site

Excavation.ie reference	Licence No.	RMP/SMR No.	Site Type	Investigation type
Geophysical survey of lands at Imphrick and Ballynageragh	20R0016	CO007-12001, CO007-12002).	Environs of medieval church and graveyard.	Geophysical Survey.
2005:181 - Ballynageragh North	05E0158	CO007-119	No archaeological significance.	Monitoring.
2006:271 - Ballynageragh North	05E0158 ext.	CO007-119	No archaeological significance.	Monitoring.

2.5.1 Previous Investigations within the site

The site was subject to two phases of geophysical survey. The first was carried out by AMS Ltd in February 2020 under licence 20R0016 (Dowling 2020). This work comprised a high-resolution magnetic gradiometer survey of Field 3 and resulted in the identification of a number of previously unknown features, many of which are of clear archaeological potential. Perhaps the most striking of these are three curving features to the east and south of the existing churchyard enclosure which were thought at the time to comprise the remains of a possible early ecclesiastical enclosure. The dense concentration of other features mapped by the survey likely represents multiperiod activity, perhaps involving settlement and/or agriculture. It consisted of four curving linears, an L-shaped anomaly, and several linears, ferrous responses, lineation etc.

The second phase was carried out by Target Archaeological Geophysics GCV on behalf of AMS Ltd in June 2020 under the same detection licence (Nicholls 2020). This high-resolution magnetic gradiometer survey investigated much of the remaining area of the site

covering c. 3.1 hectares. The site consisted of a corridor and traversed 2 low-lying pasture fields, the northern field sub-divided by post and wire fencing. A small section of the site was unavailable to survey due to cattle grazing at the time of fieldwork.

A concentration of linear anomalies, discrete positives and a large burnt/fired deposit in the southern portion of Field 2 were thought at the time to suggest remnants of a probable ecclesiastical settlement associated with the church and graveyard (CO007-120001-002). These anomalies correspond to surface visible earthworks noted at the time of fieldwork, and likely represent a continuation of the linear remains recorded from the phase 1 survey (Field 3). A series of discrete positives and weak trends of uncertain origin, responses from former boundaries, some of which correspond to historical mapping, localised variations in soil morphology/geology and modern ferrous were all detected.

3. ADVANCE TARGETED ARCHAEOLOGICAL TEST EXCAVATIONS

3.1 Aims & Objectives

Twenty test trenches (Test Trenches 1-20, Figures 5-6) were proposed for excavation across the site at XC215 Shinanagh. All test trenches were targeting potential features identified by the geophysical survey (Dowling 2020 & Nicholls 2020). The aim of the targeted test excavations was to determine the archaeological nature (if any) of the geophysical anomalies and identify any archaeological features or structures present within the excavated test trenches.

In Field 1 Test Trenches 1-9 were excavated, totalling 135 linear metres. Two areas were subject to previous geophysical survey and consisted of M2 in the northern part of the field and M3 in the southern end of the field.

In Area M2 Test trenches 1-6 targeted a series of anomalies (Target: 7, 8, 9) that appeared to represent linears and trends. These were thought to represent potential archaeological features (Anomaly 7, 8) while Anomaly 9 was interpreted as derived from former landuse. In Area M3 Test trenches 7-9 targeted Anomaly 10 represented by parallel linears northwest-southeast aligned and interpreted as part of a former boundary and/or driveway. Test Trench 9 targeted a northeast-southwest trend.

In Field 2, Test Trenches 10-15 were excavated, totalling 100 linear metres and targeted identified anomalies (Target: 12 and 15), and additional anomalies including trends and four anomalies interpreted as former boundary/land divisions, the latter were east-west aligned. Anomaly 12 was located in the south part of Field 2 and labelled as trend, while Anomaly 15 was located in the very south end of the field and included a large area labelled as a probable burnt/fired deposit, and described as poorly defined negative linears, discrete positives and trends recorded in association with earthworks immediately north of the Church and Graveyard. Anomaly 15 indicates a large burnt/fired deposit, either associated with the site of a former building or fulacht fia.

In Field 3, Test Trenches 16-20 were excavated, totalling 82 linear metres and targeted identified anomalies AMS: 1, 3-6, 8, 9, 15, 16 and a roughly north-south aligned linear representing a possible narrow ditch/drain or stone/compacted earth feature. The linear anomalies included two curving features (Anomalies 1, 3) located to the southeast and south of the existing churchyard enclosure which were suggested as comprising the remains of an early enclosure and an L shaped linear (Anomaly 4) in the form of a rectangular-shaped ditch interpreted as a possible former field or other boundary-type feature. The dense concentration of other linear features mapped by the survey (Anomalies 2, 5, 6, 8, 9) likely represents ditches associated with multiperiod activity, perhaps involving settlement and/or agriculture. Two anomalies (Anomaly 12 and 15) represent former field boundaries and are depicted on the 1st Edition Ordnance Survey 1840 map.

3.2 Methodology

3.2.1 Survey, Excavation and Recording

The test excavation was carried out in accordance with the IAI Code of Conduct for Archaeological Excavation (IAI 2006), the Method Statement and Service Requirements of the Cork Line Level Crossings Project. The excavation included the creation of a written and photographic record of the archaeology on a feature-by-feature basis using pro-forma record sheets; maintaining daily logs of excavations; and recording stratigraphic relationships and the position and depth of archaeology.

The test trenches were 1.8m wide and excavated to the surface of archaeological deposits or the underlying natural subsoil, whichever was encountered first. Natural sub-soil was exposed in all test trenches.

A mechanical excavator with a 1.8m wide ditching bucket was used to assist in the removal of topsoil and any made ground in horizontal levels of not more than 0.10m in thickness. This work was undertaken under the direct supervision of the excavation director (Ian Russell), in accordance with all current Health and Safety and regulatory legislation guidelines including COVID19 procedures. All exposed features were identified, cleaned back and tested by hand (Section 3). The reinstatement of the test trenches took place in tandem with the archaeological works. In total 317 linear metres of test trench was excavated.

All features revealed were cleaned back and tested by hand using partial excavation and half-sectioning. This work was recorded using detailed written descriptions and drawings on pro-forma field record sheets, giving details where applicable of location, composition, shape, dimensions, relationships, finds, samples, cross-references to other elements of the record and other relevant contexts. Supporting records in the form of registers or lists of drawings, photographs and samples were also created and the Excavation Director maintained a field diary.

Where features were found they were recorded three dimensionally using a combination of scale drawings and GPS surveying. Comprehensive plans and cross-sectional drawings were produced at a scale of 1:10, 1:20 or 1:50, as appropriate, and include Ordnance Datum levels. The layout of all test trenches and the locations of any features recorded within them was recorded by competent surveyors using digital survey equipment and results were plotted in ITM. A high-resolution digital camera was also used to record the excavated test trenches and any identified archaeological features.

3.2.2 Finds Retrieval and Sampling Strategies

No finds were recovered.

Palaeo-environmental samples were collected from appropriate contexts for the purposes of radiocarbon dating and the recovery of non-wood macro plant remains; and the sampling process was implemented in accordance with the TII Palaeo-environmental Sampling Guidelines (McClatchie et al. 2015) and the Institute of Archaeologists of Ireland's Environmental Sampling: Guidelines for Archaeologists (IAI 2007). The overall sampling strategy therefore adopted a systematic approach as defined in the TII guidelines, supplemented with judgement-based sampling.

Post-depositional disturbance of deposits has the potential to re-work deposits and their components and to introduce material into the deposit. As part of a rigorous approach to sampling, site staff identified the extent to which a context was stratigraphically secure prior to taking a sample. Contexts that appeared to have their stratigraphic security significantly compromised through post-depositional disturbance were not sampled. The nature and degree of disturbance and the type of material that samples are designed to retrieve are the key considerations in determining whether a deposit is sufficiently stratigraphically secure to allow sampling. For example, larger items such as pieces of preserved wood are generally less prone to post-depositional movement than smaller items such as waterlogged or charred plant seeds.

3.2.3 Conditions

The weather throughout the test excavation phase was relatively good with some cloud and showers but mostly dry conditions. A prolonged period of wet weather in advance of commencement of the investigations led to the land being extremely wet with standing surface water in some areas.

3.2.4 Constraints on Methods

All appropriate methods were used to mitigate against any potential impacts in advance of any ground excavation and all groundworks were undertaken in compliance with all relevant Construction Health and Safety Regulations. Identified constraints on the archaeological test excavations were as follows:

- (a) Pasture land: This site is in use as pasture land therefore the impact of the archaeological test excavations on the sod and topsoil had to be minimised. In order to achieve this, the excavator was tracking along the same path to minimise the impact on sod, the test trenches were carefully re-instated the same day and any large stones visible following re-instatement were collected by hand.
- (b) Goal Posts were erected where required in adherence to the Code of Practice for Avoiding Danger from Overhead Electricity Lines (2019), Test Trench 18 was moved slightly south due to overhead electric wires but still targeted the same geophysical anomaly it was designed for.

3.3 Specialist Contributions and / or Consultations

3.3.1 Artefacts

No artefacts were recovered during the test excavations. The metal detector (20R0248) was used to scan test trenches and any potential archaeological features, however, no finds were retrieved as a result.

3.3.2 Human remains

As the site was located in the immediate environs of a church and graveyard (CO007-120001-002) a provision was made in case human remains were identified on-site. Osteo-archaeologist Glenn Gibney was available to attend the site in the event that burials were identified; however, no human remains were exposed.

3.3.3 Palaeo-environmental remains

Four separate bulk soil samples were taken from pit and ditch fills (see Section 6, Table 5). All soil samples were processed by flotation and all of the samples produced sufficient quantities of charcoal from which radiocarbon dates can be obtained if required. No non-wood plant macro remains were recovered. Suitable charcoal (short-lived species) for dating will be selected by Dr Lorna O'Donnell in advance of any Radiocarbon dating program.

3.3.4 Metallurgical waste

Four separate metallurgical waste samples were taken from a spread and ditch fills (See Section 6, Table 5). All samples were cleaned and visually assessed and were found to represent smithing slag.

4. ARCHAEOLOGICAL EXCAVATION RESULTS

Twenty test trenches (Test Trenches 1-20, Figures 5-6) were excavated across the site in Ballynageragh & Imphrick townlands, targeting potential features identified by the geophysical survey (Dowling 2020 & Nicholls 2020).

Three areas of archaeological activity were identified; in the north end of Field 1, in the south end of Field 2, and within Field 3. In the northern extent of Field 1 a number of features of archaeological significance were exposed and comprised pits, post-holes, linears and ditches, all suggestive of settlement/archaeological activity within the site. While the fills of the features did not contain any datable finds, slag was retrieved and samples were taken. These samples are now processed and produced charcoal.

The features located in the south end of Field 2 were identified during geophysical survey, and targeted test trenching confirmed their archaeological significance. The features exposed consisted of linears, pits, ditches and spreads associated with metalworking with iron slag recovered from both spreads and linears.

In Field 3 a spread and a number of linears/ditches were exposed. While these did not produce any datable material, their linear nature and sterile fills are suggestive of field systems of unknown date. Their location in the immediate environs of the Church (CO007-120002-); an associated Graveyard (CO007-120001-) and Ritual site – holy well (CO007-121----) indicates that these features may potentially be associated with the medieval landscape.

It appears that most of the remaining linear features identified throughout the site are consistent with anomalies identified in the geophysical survey and represent field divisions and/or former field boundaries as well as in some cases variations in the natural geology and/or changes in the topsoil, likely of recent date.

4.1 Field 1

In Field 1 Test Trenches 1-9 were excavated, totalling 135 linear metres. Two areas were subject to prior geophysical survey and consisted of M2 in the northern part of the field, and M3 in the southern end of the field.

In Area M2 test trenches 1-6 targeted a series of anomalies (Target: 7, 8, 9) that appeared to represent linears and trends. These were thought to represent potential archaeological features (Anomaly 7, 8) while Anomaly 9 was interpreted by Target as derived from former landuse, that might represent former boundaries (See Nichols 2020, Section 2.3.1).

In Area M3 test trenches 7-9 targeted Anomaly 10 represented by northwest-southeast aligned parallel linears interpreted as part of a former boundary and/or driveway, Test Trench 9 targeted a northeast-southwest trend.

In Field 1, the following archaeological features were exposed; five pits in Test Trench 2 (C8, C12, C17, C26, C28); one pit each in Test Trench 1 (C52) and Test Trench 6 (C58); ten postholes (C10, C11, C13-16, C19-C21, C24), three stakeholes (C18, C22, C23), and two furrows (C27, C29) all in Test Trench 2. A number of ditches of potential archaeological significance and field boundaries were exposed in Test Trenches 1-6 (C53, 25, C4, C5, C56) and Test Trench 9 (C3) (see sections 4.1.1-4.1.5 for details).

A detailed description of the Field 1 test trenches is provided in Table 3.

Table 3: Field 1 Test Excavation Results, Test Trenches 1-9

Test Trench No.	Length (m)	Width (m)	Targeting anomaly /vicinity	Contexts recorded	Trench depth (m)	Description
1	10	1.8	Trend, Anomaly 9	C1, C2, C52, C53	0.5	Northwest-southeast test trench in Area M2, near the north end of Field 1 (Figures 5-6, 7,20, Plates 1-4).

Test Trench No.	Length (m)	Width (m)	Targeting anomaly /vicinity	Contexts recorded	Trench depth (m)	Description
				C54, C94, C95		Charcoal rich pit C52, bank C94 and poss. linear C53 exposed.
2	17	1.8	Trend, Anomaly 9	C8-C51, C62	0.45-0.5	Northwest-southeast test trench in Area M2, in the north end of Field 1 (Figures 5-6, 8, Plates 5-8). Archaeological activity represented by five poss. pits (C8, C12, C17, C26, C28), ten poss. postholes (C10, C11, C13-16, C19-C21, C24), three poss. stakes (C18, C22, C23), one ditch (C25) and two agricultural furrows (C27, C29). Ditch C25 might account for Trend Anomaly 6.
3	18	1.8	Trend, Anomaly 9	C1, C2, C4, C6	0.5-0.6	Northeast-southwest test trench in Area M2, in the north end of Field 1 (Figures 5-6, 9, 20 Plates 9-10). Shallow ditch (C4) northeast-southwest aligned. No apparent explanation for trend labelled as Trend/Anomaly 9.
4	10	1.8	Target 8	C1, C2, C05, C07	0.45-0.55	Northeast-southwest test trench in Area M2, in the north end of Field 1 (Figures 5-7, 20, Plates 11-13). Ditch C5 accounts for Anomaly Target 8, charcoal rich fill, contains slag, accounts for Anomaly 8
5	14	1.8	Trend, Anomaly 9	C1, C2, C55, C96	0.45-0.5	Northwest-southeast test trench at the southern part of Field 1 (Figures 5-6, 10, Plates 14-15). Linear (C55) exposed, accounting for trend labelled as Anomaly 9.
6	12	1.8	Trend, Anomaly 9	C1, C2, C56, C57, C58, C59, C60, C61	0.45-0.5	Northeast-southwest test trench in Area M2, in the north end of Field 1 (Figures 5-6, 10, Plates 16-18). Pit (C58) and linears (C56, C57) were exposed, the latter may account for trend labelled as Anomaly 9.
7	22	1.8	Target 10	C1, C2,	0.35-0.4	Northwest-southeast test trench in Area M3, at the southern part of Field 1 (Figures 5-6, Plate 19). No archaeological features. The geophysical Anomaly Target 10 lines up with a change in the natural boulder clay.
8	22	1.8	Target 10	C1, C2	0.35-0.4	Northwest-southeast test trench in Area M3, at the southern part of Field 1 (Figures 5-6, Plate 20). No archaeological features. The geophysical Anomaly Target 10 lines up with a change in the natural boulder clay.
9	10	1.8	Trend	C1, C2, C3, C92	0.35-0.4	Northwest-southeast test trench in Area M3, at the southern part of Field 1 (Figures 5-6, 11, 23, Plates 21, 22). Ditch C3 accounts for anomaly labelled as Trend, it was found to represent a field boundary and is not of archaeological significance.

4.1.1 Pits

In total 7 pits were exposed in Field 1; five pits in Test Trench 2 (C8, C12, C17, C26, C28); one pit each in Test Trench 1 (C52) and Test Trench 6 (C58).

In **Test Trench 1** an oval, charcoal-rich pit C52 was exposed (Figure 7, 20, Plates 2-4) measuring 0.9m by 0.8m, c. 0.14m deep with a single fill C54 that consisted of dark greyish black sandy clay with frequent inclusions of charcoal and small to medium fire-cracked stones. A soil sample was taken for possible radiocarbon dating (Sample 2). This pit was similar to pit C8 exposed in Test Trench 2.

In **Test Trench 2** five pits were exposed, these consisted of C8, C12, C17, C26, C28 (Figure 8). Pit C8 was located within the northwest extent of the trench. It was oval in shape, measuring 0.97m by 0.75m, and filled by C30 that consisted of a dark greyish black sandy

clay with frequent inclusions of charcoal and small to medium fire-cracked stones (Plate 5). This pit was similar to pit C52 exposed in Test Trench 1.

Both pits C12 and C17 were irregular in shape; C12 measured 0.6m by 0.75m, while C17 measured 0.5m by 0.2m and both were filled by a mid brownish-grey clay with inclusions of charcoal, C34 and C39 respectively (Plate 5).

Pits C26 and C28 were oval in shape, located in the northeast extent of the test trench and were only partially exposed, both extending into the baulk to the south. C26 measured 1.2m by 0.6m and was filled by C48 while C28 measured 1.4m by 0.6m and was filled by C50. Both fills consisted of a mid-brownish-grey sandy clay (Plate 5).

In **Test Trench 6** oval pit C58 was partially exposed (Figure 10); it was 0.8m long, 0.46m wide as exposed within the test trench and it extended north. Pit C58 was 0.25m deep and filled by C60 a pale greyish brown silty sand, sterile in nature.

4.1.2 Postholes

In total ten postholes were exposed, all within **Test Trench 2**; these consisted of C10, C11, C13-16, C19-C21, C24 (Figure 8, Plates 5-6).

The postholes varied in form from oval to circular, measuring between 0.16-0.4m in diameter and were filled by a mid-brownish-grey sandy clay with charcoal inclusions. No pattern was apparent. Details of these postholes including fill and measurements are supplied in the table below:

Table 4: Details of post-holes in Test Trench 2

Context	Filled by	Measurements (m)
C10	C32	0.2 \emptyset
C11	C33	0.25 \emptyset
C13	C34	0.3 x 0.25
C14	C35	0.35 \emptyset
C15	C36	0.3 x 0.26
C16	C37	0.3 \emptyset
C19	C41	0.2 x 0.17
C20	C42	0.16 \emptyset
C21	C43	0.4 \emptyset
C24	C46	0.38 \emptyset

4.1.3 Stakeholes

In Field 1, in total three stakeholes (C18, C22, C23) were identified, all in **Test Trench 2** (Figure 8, Plate 5). No remains of wooden stakes were visible on the surface, and all were filled by a mid-brownish-grey sandy clay with charcoal inclusions. Stakeholes C18 and C23 were filled respectively by C40 and C45, both measured 0.1m in diameter, while C22 was filled by C44 and measured 0.12m in diameter. No pattern was apparent.

4.1.4 Ditches

Linear features in the form of ditches of potential archaeological significance and field boundaries were exposed in Test Trenches 1-6 (C53, 25, C4, C5, C56) and Test Trench 9 (C3). Some represented anomalies identified during the geophysical survey (Figure 5).

In **Test Trench 1** (Figure 7) following removal of bank C94, a north-south aligned linear C53 was exposed (Plate 2) measuring 0.4m in width and filled by C95 a pale brownish-grey sandy sterile clay. This linear is on the same alignment as C25 and C56, and accounts for an anomaly labelled as 'trend' by the geophysical survey,

In **Test Trench 2** (Figure 8) a ditch C25 was exposed and sectioned (Figure 20, Plates 6-8). It was northeast-southwest aligned, measured 2.3m in width and was 0.73m deep. The cut of the east slope was steep with the south more gradual. Ditch C25 was filled with upper fill C47 and basal fill C62. The upper fill C47 consisted of a mid-brownish-grey silty clay with charcoal and was 0.33m deep, while the basal fill C62 measured 0.4m and consisted of a brownish-grey silty sand with frequent inclusions of small stones. The ditch C25 was on the same alignment as C53 and C56 and accounts for Anomaly 6 labelled as 'trend' on the geophysical survey.

In **Test Trench 3** (Figure 9) a feature of possible archaeological significance was identified and was represented by a northeast-southwest aligned shallow ditch (C4). It measured 1.7m in width and was 0.35m deep. It measured 14.2m in length within the test trench (Figure 20, Plates 9-10). It was filled by C6 a reddish-brown sandy clay with frequent small stones with rare charcoal flecks.

This ditch was on the same alignment as the field boundary depicted on the 1st Edition Ordnance Survey 1840 map and might represent part of a minor field system. This ditch was not identified in the geophysical survey, and no explanation for the trends depicted in the geophysical survey was apparent.

In **Test Trench 4** (Figure 7) a northwest-southeast aligned ditch C5 was sectioned and deemed of potential archaeological significance. The ditch was U-shaped with steep almost vertical sides and a flat base. It measured between 0.8-1m in width and was 0.34m deep. Ditch C5 was filled by C7 that consisted of a dark greyish brown sandy clay with frequent charcoal, iron slag and large flat stones at the base (Figure 20, Plates 12.13). Iron slag was retrieved from its fill – Sample 1. Ditch C5 accounts for Anomaly 8 detected by Target.

In **Test Trench 5** (Figure 10) a north-south aligned ditch C56 was exposed, and measured between 1.2 to 1.3m in width and was filled by C61 that consisted of a mid-brownish-grey sandy clay (Plate 15). This ditch was on the same alignment as C25 and C53 and accounts for Anomaly 6 depicted as 'trend' by Target.

In **Test Trench 6** (Figure 10) a northwest-southeast aligned ditch C57 was exposed, and measured 2.3m in width and was filled by C59 a pinkish-grey silt (Plate 17).

In **Test Trench 9** (Figure 11) an east-west ditch C3 was exposed, and measured 1.2m in width and was 0.25m deep. The ditch was V-shaped, and filled by C92 that consisted of a pale greyish brown sandy clay. Ditch C3 accounts for a trend noted in the geophysical survey. The ditch aligns with a field boundary shown on the 1st Edition Ordnance Survey Map of 1840 (Figure 23a). It is therefore assumed to be of 19th-century date and not of archaeological significance.

4.1.5 Furrows

In total two furrows were exposed in Field 1. These were exposed in the northeast extent of **Test Trench 2** and consisted of two parallel northeast-southwest aligned agricultural furrows (C27, C29). Both measured 0.4m in width and 0.05m in depth and were filled by a mid brownish-grey sandy clay (Figure 8). Furrow C27 was filled by C49 and truncated pit C26, while furrow C29 was filled by C51 and truncated pit C28 (Plate 6).

4.2 Field 2

In Field 2, Test Trenches 10-15 were excavated, totalling 100 linear metres and targeted identified anomalies Target 12 and 15, and additional anomalies including trends and four anomalies interpreted as former boundary/land divisions, the latter were east-west aligned. Anomaly 12 was located in the south part of Field 2 and labelled as 'trend', while Anomaly 15 was located in the very south end of the field and included a large area labelled as a probable burnt/fired deposit and described as poorly defined negative linears, discrete positives and trends recorded in association with earthworks immediately north of Church and Graveyard CO007-120001/002, likely

associated with an ecclesiastical settlement. Anomaly 15 was interpreted as a large burnt/fired deposit, either associated with the site of a former building or fulacht fia.

Test trenching in Field 2 exposed a total of thirteen ditches/linears (C64, C63, C80, C81, C74, C75, C76, C67, C68, C69, C85, C87, 129), one pit (C84) and three spreads (C86, C88, C89) (see sections 4.2.1 – 4.2.3 for details).

A detailed description of the Field 2 test trenches is provided in Table 5.

Table 5: Field 2 Test Excavation Results, Test Trenches 10-15

Test Trench Number	Length (m)	Width (m)	Targeting anomaly	Contexts recorded	Trench depth (m)	Description
10	14	1.8	?Former boundary/land division	C1, C2, C64, C65	0.3	North-south test trench at the north end of Field 2 (Figures 6, 12, 23, Plates 23, 24). No archaeological features. Ditch C64 accounts for anomaly identified in Geophysics, it was found to represent a field boundary and is not of archaeological significance.
11	11	1.8	?Former boundary/land division	C1, C2, C63, C66	0.35	North-south test trench at the north end of Field 2 (Figures 6, 12, 23 Plates 25, 26). Ditch C63 accounts for anomaly identified in Geophysics as a field boundary by Target .
12	17	1.8	?Former boundary/land division & Anomaly 12 labelled as trend	C1, C2, , C80, C81, C82, C83	0.45-0.55	North-south test trench at the southern end of Field 2 (Figures 6, 13, Plates 27-28). Two linears C80 and C81. C80 corresponds with Anomaly interpreted as ?Former boundary/land division, while C81 corresponds with Anomaly 12, labelled as trend. While no boundary is depicted on the Ordnance Survey maps at this location, the east-west alignment of the features suggests these are associated with field divisions.
13	12	1.8	?Former boundary/land division	C1, C2, C74, C75, C76, C77, C78, C79	0.45-0.55	North-south test trench at the southern end of Field 2 (Figures 6, 13, 20, 24 Plates 29-31). Three ditches exposed C74, C75, C76. C74 accounts for anomaly interpreted as a field boundary in the geophysics and was found to represent a field boundary and is not of archaeological significance, while C75 and C76 may represent field divisions of unknown date and were not identified during geophysics.
14	16	1.8	Trend	C1, C2, C67, C68, C69, C70, C71, C72, C73, C129, C130	0.45-0.55	Northeast-southwest test trench in the southern part of Field 2 (Figures 6, 14, 21, Plates 32-35). Four linears were identified (C67, C68, C69, C129), of which C129 as sealed by a spread (C70). Ditch C67 accounts for an Anomaly identified as trend in Geophysics, it was found to represent a field boundary and is not of archaeological significance.
15	39	1.8	Anomaly 15	C1, C2, C84, C85, C86, C87, C88, C89, C90, C91, C93, C97	0.45-0.6	North northeast-south southwest test trench at the south end of Field 2 (Figures 6, 15, 21 Plates 36-40). The archaeological activity represented by two pits (C84, C86), two linears (C85, C87) and two spreads (C88, C89) all filled by charcoal-rich, stony material and correspond with a series of anomalies interpreted as ?Archaeology – probable burnt/fired deposit in the Geophysical Survey.

4.2.1 Ditches

Linear features in the form of ditches of identified or potential archaeological significance and field boundaries were exposed in all test trenches in Field 2 (C64, C63, C80, C81, C74, C75, C76, C67, C68, C69, C85, C87, C129). Some represented anomalies identified during geophysical survey (Figure 6) or correspond with field boundaries (see Figures 23-24).

In **Trench 10** (Figure 12) an east-west aligned linear C64 was exposed measuring 1.4m in width, 0.2m deep, and visible as a depression outside the test trench measuring c. 2.2m in width at its top. Ditch C64 was filled by C65 that consisted of a brownish-grey stony clay (Plate 24). Ditch C64 accounts for an anomaly interpreted as field boundary by Target. The ditch aligns with the field boundary shown on the 1st Edition Ordnance Survey Map of 1840 (Figure 2). It is therefore assumed to be of 19th-century date and not of archaeological significance.

In **Test Trench 11** (Figure 12) an east-west aligned ditch C63 was exposed; it measured 1.6m in width and was filled by C66 that consisted of a brownish-grey stony clay (Plates 25, 26). It may represent a former field boundary. Ditch C63 accounts for an anomaly labelled as field boundary by Target. No boundaries are depicted on the Ordnance Survey Map at this location, however, this ditch is parallel with the field boundaries in the area, and therefore might represent part of a former field system.

In **Test Trench 12** (Figure 13) two ditches were exposed (C80, C81). Ditch C81 was east-west aligned, it measured 1.3m in width, and was filled by C83 a sterile grey silty clay with decaying stone inclusions (Plate 27). Ditch C81 accounts for an anomaly labelled as field boundary by Target, and aligns with a field boundary depicted on the 1st Edition Ordnance Survey 1840 map. It is therefore assumed to be of 19th-century date and not of archaeological significance.

Ditch C80 was also east-west aligned, it measured 1.7m in width, and was filled by C82 a sterile grey silty clay with small stone inclusions (Plate 28). Ditch C80 accounts for an anomaly labelled as trend by Target. It might represent part of a field system of unknown date.

In **Test Trench 13** (Figure 13) three linears were exposed (C74, C75, C76). Ditch C74 was east-west aligned, it measured 1.5m in width and 0.5m in depth, the sides had a gradual slope, the base was round, and it was filled by C77 a sterile orange-brown clay with frequent small stones at the base (Figure 20, Plate 30). Ditch C74 accounts for an anomaly labelled as field boundary by Target. The ditch aligns with the field boundary shown on the 1st Edition Ordnance Survey Map of 1840 (Figure 24a). It is therefore assumed to be of 19th-century date and not of archaeological significance. Ditch C75 was east-west aligned, it was truncated by C76. The cut had steep sides and a round base. It was filled by C79 a sterile whitish-grey sand (Plate 31), while ditch C76 was north-south aligned, measuring 0.6m in width, and filled by C78 that consisted of a mid-grey silty sand (Plate 29).

Ditches C75 and C76 were not identified on the geophysics, and might represent part of a field boundary of unknown date.

In **Test Trench 14** (Figure 14) four linears were exposed (C67, C68, C69, 129). Ditch C67 was northwest-southeast aligned and measured 2.5m in width and was 0.4m deep. It was visible as a depression outside the test trench, and was filled by C71, a dark grey sandy clay (Figure 21, Plate 32, 34). Ditch C67 accounts for an anomaly labelled as trend by Target. It aligns with the field boundary depicted on the 1st Edition Ordnance Survey Map 1840. It is therefore assumed to be of 19th-century date and not of archaeological significance.

Ditches C68 and C69 were parallel, northwest-southeast aligned and measured respectively 0.4m and 0.6m in width. Both were filled by pale grey sandy clay with inclusions of charcoal and patches of orange sand. Ditch C68 was filled by C72, while ditch C69 was filled by C73 (Plate 33). These features were not visible on the geophysics but due to their alignment with existing field boundaries might represent part of a former field boundary of unknown date.

A linear C129 was exposed following removal of spread C70. It was northeast southwest aligned, measured min. 3.3m in length, 0.24m in width and was 0.1m deep. It was filled by C130 that consisted of dark grey sandy clay with charcoal and medium size stone inclusions (Figure 21, Plate 33, 34)

In **Test Trench 15** (Figure 15) two linears of archaeological significance were exposed (C85, C87). Both were parallel and northeast-southwest aligned (Plate 36). Ditch C85 measured 0.55m in width and was 0.34m deep, filled by upper fill C91, a pale greyish brown sandy clay with stones, charcoal and some slag, sealing C97 a dark greyish brown sandy clay with frequent inclusions of iron slag and charcoal (Figure 21, Plate 38, 39). Ditch C87 measured 1.2m in width and was filled by C93 a brownish-grey sandy clay with inclusions of charcoal, and small to medium stones (Plate 37). Ditches C87 and C85 appeared of similar form therefore C85 was tested. Both

ditches account for Anomalies 15, which were interpreted as representing a probable burnt/fired deposit of archaeological significance. The linears appear to be associated with metalworking.

4.2.2 Pit

In total one pit was exposed in Field 2, in **Test Trench 15** (C84). C84 was partially exposed, oval in shape, measured 1.4m in length, 1.1m in width and was 0.15m deep (Figure 15, 21, Plate 38, 40). The south side was steep while the north was more gradual, and it was filled by C90 that consisted of a brownish-grey sandy clay with inclusions of charcoal, small to medium stones and decaying stones. Pit C84 accounts for Anomaly 15, which represented a series of anomalies interpreted as a probable burnt/fired deposit by Target.

4.2.3 Spreads

In total four spreads were exposed in Field 2, in Test Trench 14 (C70) and in Test Trench 15 (C86, C88, C89).

In **Test Trench 14** (Figure 14) spread C70 was exposed, it consisted of grey sandy clay with charcoal and medium size stone inclusions and was c. 0.2m deep, it was sealing linear C129 (Figure 21, Plate 33, 34). This spread was deemed to be of archaeological significance.

In **Test Trench 15** three spreads were exposed (C86, C88, C89). All were partially exposed and extended outside of the test trench to the east and west (Figure 15, Plate 37). Spread C86 measured 1m by 1m where exposed, and consisted of a dark blackish-brown sandy clay, with frequent inclusions of charcoal, and small to medium heat shattered stones, while C88 measured 6.5m in length within the trench and comprised a mid-blackish-brown sandy clay, with frequent inclusions of charcoal and small to medium heat shattered stones. Spread C89 measured a minimum of 3.5m in diameter where exposed and was a dark blackish-brown sandy clay, with frequent inclusions of charcoal and small to medium heat shattered stones. Iron slag was retrieved and sampled (Sample 4). These spreads were found to be of archaeological significance and extended outside of the trench to the east and west (C88, C89) and west (C86). In order to minimise the impact on grazing land it was not permissible to extend the trench layout to define the full extent of the feature. Due to inclement weather and the flooding of the trench it was not possible to excavate the section through the feature without potentially compromising the archaeology. All spreads account for Anomaly 15, which represented a series of anomalies interpreted as a probable burnt/fired deposit of archaeological significance.

4.3 Field 3

In Field 3, Test Trenches 16-20 were excavated, totalling 82 linear metres and targeted identified geophysical anomalies (AMS: 1, 3-6, 8, 9, 15, 16) and a roughly north-south aligned linear representing a possible narrow ditch/drain or stone/compacted earth feature. The linear anomalies included two curving features (Anomalies 1, 3) located to the southeast and south of the existing churchyard enclosure which was suggested might represent the remains of an early enclosure and an L shaped linear (Anomaly 4) in the form of a rectangular-shaped ditch interpreted as a possible former field or other boundary-type feature. The dense concentration of other linear features mapped by the survey (Anomalies 2, 5, 6, 8, 9) likely represents ditches associated with multiperiod activity, perhaps involving settlement and/or agriculture. Two anomalies (Anomaly 12 and 15) represent former field boundaries and are depicted on the 1st Edition Ordnance Survey 1840 map.

Test trenching in Field 3 exposed a total of twelve ditches/linears (C98, C99, C102, C107, C108, C112-C116, C121, C122) and two spreads (C103, 106) (see sections 4.3.1 – 4.3.2 for details).

A detailed description of the Field 3 test trenches is provided in Table 6.

Table 6: Field 3 Test Excavation Results, Test Trenches 16-20

Test Trench Number	Length (m)	Width (m)	Targeting anomaly	Contexts recorded	Trench depth (m)	Description
16	25	1.8	AMS 16, 9, 8	C1, C2, C112, C113, C114, C115, C116, C117, C118, C119, C120, C125, C126, C127, C128	0.3-0.45	North northeast-south southwest test trench in the northern end of Field 3 (Figures 6, 16, 21, 22, 24, Plates 41-45). Ditch C116 accounts for Anomaly AMS 16 and represents a 20-century boundary and is therefore not of archaeological significance. Ditch C115 accounts for Anomaly AMS 9, while C112 accounts for Anomaly 8. Two parallel ditches C114 and C113 and C112, C115 are associated and represent part of a field system of unknown date.
17	20	1.8	AMS 6, 4	C1, C2, C121, C122, C123, C124	0.3-0.45	North northeast-south southwest test trench in the south part of Field 3 (Figures 6, 17, 22, 24 Plates 46-48). Two parallel ditches C121 and C122 account for respectively for Anomalies 6 and 4, and are associated with the north-south field boundary depicted on the 1 st Edition Ordnance Survey 1840 map and are associated with 19th-century boundary and therefore not of archaeological significance.
18	8	1.8	AMS 5, 15	C1, C2, C105, C106, C107, C108, C109, C110,	0.3-0.4	Northeast-southwest test trench in the south part of Field 3 (Figures 6, 18, 24, Plates 49-51). Ditch C108 accounts for Anomaly 15 representing field boundary depicted on the 1st Edition Ordnance Survey 1840 map and are associated with a 19th-century boundary and therefore not of archaeological significance. While ditch C107 accounts for Anomaly 5 and is associated and represent part of a field system of unknown date. Poss. spread C106 was not identified during geophysics, and extended to the northwest and outside of the test trench.
19	13	1.8	AMS 15	C1, C2, C102, C103, C104	0.3-0.4	Northeast-southwest test trench in the south part of Field 3 (Figures 6, 18, 24, Plate 52). Ditch C102 accounts for Anomaly 15 representing field boundary depicted on the 1st Edition Ordnance Survey 1840 map and are associated with a 19th-century boundary and therefore not of archaeological significance. Spread C103 was not identified during geophysics, and extended to the northwest and outside of the test trench.
20	16	1.8	AMS 1, 2	C1, C2, C98, C99, C100, C101, C111	0.35-0.55	Northeast-southwest test trench in the south part of Field 3 (Figures 6, 19, 22, Plates 53-56). Two ditches C98 and C99 account for anomalies 1 and 2 respectively, and are associated with an old field system of unknown date.

4.3.1 Ditches

In total 12 linear features in the form of ditches of potential archaeological significance or representing field systems of unknown date and field boundaries of known date were exposed in all test trenches in Field 3 (C98, C99, C102, C107, C108, C112-C116, C121, C122). Some represented anomalies identified during the geophysical survey (Figures 6) or are associated with field boundaries/divisions (Figure 3, 4, 23B-24) shown on OS mapping.

In **Test Trench 16** (Figure 16) five linears were exposed (C116, C115, C114, C113, C112) and all were east-west aligned. Ditch C116 measured 2m in width and 1.2m in depth, filled with basal fill C128 and upper fill C125. The basal fill C128 consisted of a brownish-grey clay with frequent inclusions of loose medium sized stones and measured 1.2m in depth, while the top fill C125 consisted of a pale grey sandy clay, and was 1.5m wide and 0.2m deep (Figure 22, Plate 42). Ditch C116 accounts for Anomaly 16 by AMS, interpreted as a field boundary on early OS mapping. The ditch aligns with the field boundary shown on the 3rd Edition Ordnance Survey Map of 1903 (Figure 4). It is therefore assumed to be of 20th-century date and not of archaeological significance.

Ditch C115 measured 1.65m in width, and 0.45m in depth, was filled with C120 a very sterile pale greyish brown sandy clay (Figure 21, Plate 45). It accounts for Anomaly 9 by AMS.

Ditch C112 measured 1.8m in width and was 0.83m deep, filled with upper fill C117, middle fill C118 and basal fill C119, all very sterile in nature. The basal fill C119 consisted of a dark brownish-grey sandy clay with inclusions of small to medium sized stones and measured 0.3m in depth. It was sealed by C118 a mid-brownish-grey sandy clay measuring 0.4m in depth. The upper fill C117 consisted of a pale brownish-grey sandy clay and measured 0.18m in depth (Figure 22, Plate 41, 43). Ditch C112 accounts for Anomaly 8 in the geophysical survey.

Ditch C113 measured 1.8m in width and 0.1m in depth (Plate 44), while ditch C114 was 0.5m wide. Both were filled by a very sterile pale greyish brown sandy clay; C113 was filled by C126 while C114 was filled with C127 (Plate 41).

Ditches C112-C115 likely represent field boundaries or divisions of unknown date.

In **Test Trench 17** (Figure 17) two north-south aligned, parallel ditches C121 and C122 were exposed. Both were filled by a greyish brown sandy clay. Ditch C121 was filled by C123 and measured 1m in width and 0.2m in depth (Figure 22, Plate 47), while C122 was filled by C124 and measured 2m in width and 0.33m in depth (Figure 22, Plate 48). Ditches C121 and C122 account for Anomalies 6 and 4 respectively in the geophysical survey, and are associated with a north-south field boundary depicted on the 1st Edition Ordnance Survey 1840 map (Figure 24b) and are therefore not of archaeological significance.

In **Test Trench 18** (Figure 18) two ditches were exposed C107 and C108. Ditch C107 was north-south aligned, measured 1.2m in width, and was filled by C109 a brownish-grey sandy clay sealing C110 a charcoal rich dark brownish-grey sandy clay (Plates 49, 50). Ditch C107 accounts for Anomaly 5 identified by the AMS geophysical survey. This ditch is parallel and west of a field boundary visible on the 1st Edition Ordnance Survey Map of 1840, and may represent part of an old field division.

Ditch C108 was east-west aligned and measured 1.5m in width and is the same as C102. It was filled by C105 a greyish brown sandy clay with inclusions of small stones (Plates 51). Ditch C108 is the same as ditch C102 exposed in Test Trench 19, and accounts for Anomaly 15 by AMS. This ditch aligns with a field boundary shown on the 1st Edition Ordnance Survey Map of 1840 (Figure 24b).

In **Test Trench 19** (Figure 18) ditch C102 was exposed, measuring 1.5m in width, and is the same as C108 exposed in Test Trench 18. It was filled by C104 a greyish brown sandy clay with inclusions of small stones (Plate 52). Ditch C102 accounts for Anomaly 15 identified by AMS. This ditch aligns with a field boundary shown on the 1st Edition Ordnance Survey Map of 1840 (Figure 24b).

In **Test Trench 20** (Figure 19) two ditches were exposed, C98 and C99. Ditch C98 was northwest-southeast aligned and measured 0.7m in width, and was filled by C100 that consisted of a pale grey silty clay (Plate 56). Ditch C99 was east-west aligned and measured 2.3m in width and 1.4m in depth. It was filled by upper fill C101 and basal fill C111. Basal fill C111 consisted of a greyish blue clay with frequent stone inclusions and was 0.4m deep, and was sealed by top-fill C101. C101 was a mid-grey-brown sandy clay and measured 2.3m in width and 0.4m in depth (Figure 22, Plate 53-55). Ditches C98 and C99 account for anomalies 1 and 12 identified by AMS respectively, and form a part of an old field system of unknown date visible in the Topographic Survey.

4.3.2 Spreads

In total two spreads were identified in Field 3 in Test Trench 18 (C106) and in Test Trench 19 (C103). Both spreads C103 and C106 were partially exposed (Figure 18); C106 consisted of charcoal, stone and clay, and measured 3m in length where exposed (Plate 49), while spread C103 measured 2m in length and consisted of stone and charcoal (Plate 52). These potentially might represent the remains of two fulacht fiadh. As the full extent of the spreads could not be established within the trench, it was decided that any section through part of the spreads exposed would potentially be misleading and unrepresentative and resulted in the decision to document the spreads in plan only.

5. ARTEFACT CATALOGUE

No finds were recovered.

6. SAMPLE REGISTER

Table 7: List of samples

Sample No.	Context No.	Description	Type	Vol (lt)	Processing	Result
1	C7	Collected from linear C5	Slag	N/A	Cleaned, visual Assessment	Smithing slag
2	C54	Collected from fill of charcoal rich pit C52	Soil sample	1 bag	Processed by flotation	Charcoal retrieved
3	C73	Collected from fill of linear C69 (surface)	Slag	1 bag	Cleaned, visual Assessment	Smithing slag
4	C89	Collected from spread (surface)	Slag	1 bag	Cleaned, visual Assessment	Smithing slag
5	C97	Collected from base of ditch C85	Slag	1 bag	Cleaned, visual Assessment	Smithing slag
6	C118	Collected from middle ditch C112	Soil sample	1 bag	Processed by flotation	Charcoal retrieved
7	C120	Collected from fill of ditch C115	Soil sample	1 bag	Processed by flotation	Charcoal retrieved
8	C119	Collected from poss. Linear C112	Soil sample	1 bag	Processed by flotation	Charcoal retrieved

7. DISCUSSION

This programme of Advance Targeted Archaeological Test Excavations was carried out to assess the archaeological nature of anomalies detected during earlier geophysical surveys (20R0016, Dowling 2020; Nicholls 2020) and inform the Cork Line Level Crossings Project Environmental Impact Assessment Report (EIAR).

Ian Russell of ACSU undertook the test excavations under licence 20E639 between the 18th and 25th November 2020. A metal detector was used under licence 20R248 to scan all relevant archaeological and potential archaeological soils. A total of 20 test trenches were

excavated targeting anomalies identified, using a 14 tonne tracked excavator fitted with a 1.8m wide toothless bucket. In total 317m of linear test trenches were excavated. Anomalies identified during the geophysical surveys (20R0016) were targeted (Test Trenches 1-20). In general, the average thickness of the topsoil measured c. 0.3-0.6 m and consisted of a greyish brown sandy clay exposing natural, that varied between greyish-yellow sandy clay and pale orange grey marl.

Three areas of archaeological activity were identified; in the north end of Field 1, the south end of Field 2, and within Field 3.

In the north extent of Field 1 several features of archaeological significance were exposed and comprised pits, post-holes, linears and ditches, all suggestive of settlement/archaeological activity within the site. While the fills of the features did not contain any datable finds, iron slag was retrieved and samples were taken. These are now processed and produced charcoal suitable for radiocarbon dating. A total of 7 pits, five pits in Test Trench 2 (C8, C12, C17, C26, C28), one pit each in Test Trench 1 (C52) and Test Trench 6 (C58), ten postholes (C10, C11, C13-16, C19-C21, C24), three stakeholes (C18, C22, C23), and two furrows (C27, C29) all in Test Trench 2. A number of ditches of potential archaeological significance and field boundaries were also exposed in Test Trenches 1-6 (C53, 25, C4, C5, C56) and Test Trench 9 (C3).

The features located in the south end of Field 2 were identified during geophysical survey, and targeted test trenching confirmed their archaeological significance. The features exposed consisted of linears, pits, ditches and spreads associated with metalworking with iron slag retrieved from both the spreads and linears. These appear to be located on a raised natural plateau defined by a scarp on the west and north that did not show any evidence for modification during the test trenching. A total of thirteen ditches/linears (C64, C63, C80, C81, C74, C75, C76, C67, C68, C69, C85, C87, 129), one pit (C84) and three spreads (C86, C88, C89) were exposed in Field 2 and represent settlement or industrial activity on the oval shaped raised plateau, possibly associated with the church to the south.

In Field 3 a spread and a number of linears/ditches were exposed, and did not produce any datable material, but their linear nature and sterile fills are suggestive of field ditches of unknown date. The location of these features in the immediate environs of the Church (CO007-120002-); an associated Graveyard (CO007-120001-) and Ritual site – holy well (CO007-121---) could suggest that they are associated with the medieval landscape. A total of twelve ditches/linears (C98, C99, C102, C107, C108, C112-C116, C121, C122) and two spreads (C103, 106) were exposed in Field 3.

A number of environmental samples from the various features, including pit and ditch fills were taken on site. Some of these produced charcoal and it is recommended that a number of these be submitted for radiocarbon dating in order to better understand the nature and dating of the features exposed. As the proposed Cork Line Level Crossings Project will require significant ground works, all identified features will be directly impacted. Where preservation in situ is not feasible, full preservation by record (i.e. archaeological excavation) in advance of construction works commencing will therefore be required in order to mitigate this permanent impact. The possible presence of other smaller archaeological features along this route in the un-tested areas can not be dismissed; therefore it is recommended that the area is subject to more general test trenching throughout the full land take area in advance of construction works commencing. The particulars of any mitigation measures will be included in the Environmental Impact Assessment Report for the scheme.

8. POST-EXCAVATION PROPOSAL

8.1 Artefacts

No artefacts were recovered during the test excavations and no further specialist analysis is proposed.

8.2 Palaeo-environmental remains

Four of the environmental samples produced sufficient quantities of charcoal from which radiocarbon dates could be obtained. Subject to the radiocarbon dating proposal in Section 8.3 being approved below, charcoal suitable for dating (i.e. charcoal from short-lived species) will be identified by Palaeo-environmental specialist Dr Lorna O Donnell and submitted to the Radiocarbon laboratory. Full charcoal analysis at this testing stage of the project is likely to contribute very little and is not required.

8.3 Radiocarbon Dating Proposal

Sufficient charcoal was recovered from four of the soil samples processed but two samples (Samples 6 & 8) are from the same feature (C112). Sample 8 is regarded as a more secure context with plenty of suitable charcoal. Sample 2 was from the fill of pit C52, and sample 7 was from the fill of linear C115. It is recommended that, as a minimum, radiocarbon dates should be obtained from C119 (S8) and C52 (S2) with C120 (S7) being an optional third date (Table 8).

Table 8: Radiocarbon Dating Proposal

Sample No.	Context No.	Sample type	Description	Reason for Dating
2	C52	Charcoal	Collected from fill of pit C54	Best available sample to date pit C54
7	C120	Charcoal	Collected from ditch C115	Best available sample to date possible enclosure C115
8	C119	Charcoal	Collected from basal fill of ditch C112	Best available sample to date ditch C112

9. RECOMMENDATIONS

The construction of the proposed upgrade to the existing overbridge and a tie in to the existing local road to the north and a new access road to connect the local road at the west side of level crossing XC215 Shinanagh for the Cork Line Level Crossings Project will entail significant groundworks. This will entail bulk excavation works, which will result in a direct permanent impact on all sub-surface archaeological remains which may potentially exist at this location.

Full preservation by record (i.e. archaeological excavation) unless preservation in situ is not feasible, of all identified archaeological features that might be exposed is recommended. This programme of targeted test trenching was limited, therefore further test trenching is recommended, as additional, unknown, sub-surface archaeological remains may be present within the untested areas. Details of all mitigation measures will be set out in the Environmental Impact Assessment Report for the scheme.

The requirement for preservation by record or if possible in situ extends to all lands which may be acquired (both temporary and permanent) and impacted at this location in order to facilitate the successful installation of the new access road at level crossing XC215 Shinanagh that is a part of the Cork Line Level Crossings Project.

9.1. Further Work

It is recommended that three samples be sent for radiocarbon dating as outlined above (Pit C52 (S2), Ditches C115 (S7) and C112 (S8)) subject to approval by the client. Should these be carried out, the results of the Radiocarbon dates, will be submitted to the relevant authorities upon receipt as a supplementary appendix to this report.

10. INVENTORY OF FEATURES

Context	Type	Description	Trench	Measurements (m)	Associated Cut / Fill	Samples	Figures	Plates
C1	Topsoil	Greyish brown sandy clay topsoil under grass sod	All	0.3-0.6 (d)				All
C2	Natural	Natural greyish-yellow sandy clay (Test Trenches 1-6, 10-20) and pale orange grey marl (Test Trenches 7-9).	All	-				All
C3	Cut of ditch	<p>Cut of ditch (C3), cut into natural C2 (marl). The ditch was V-shaped, aligned east-west, filled by C92.</p> <p>Accounts for a trend noted in geophysical survey. The ditch aligns with the field boundary shown on the 1st Edition Ordnance Survey Map of 1840. It is therefore assumed to be of 19th-century date and not of archaeological significance.</p>	9	1.2 (w) 0.25 (d)	C92		Figs 5, 6, 9	Plate 21, 22
C4	Cut of ditch	<p>Cut of ditch (C4), cut into natural C2. Northeast-south west aligned linear/shallow ditch. With sloping sides - the north slope was steep and the south was more gradual, the base was flat. It measured c. 1.7 m in width and 0.35m in depth. It was filled by reddish-brown sandy clay with frequent small stones with rare charcoal flecks (C6) Not visible on geophysical survey..</p>	3	Min. 14.2 (l) 1.7m (w) 0.35 (d)	C6		Figs 5, 6, 20	Plates 9, 10
C5	Cut of ditch	<p>Cut of ditch C5, cut into natural C2. U-shaped with steep, nearly vertical sides and flat base. It measured between 0.8-1m in width and was 0.34m deep and was northwest-southeast aligned. Filled by C7, dark greyish brown sandy clay with frequent charcoal, slag and large flat stones at the base. Slag/vitrified material retrieved – Sample 1.</p> <p>Accounts for Anomaly Target 8.</p>	4	0.8-1 (w), 0.34 (d)	C7	1 (slag)	Figs 5, 6, 20	Plates 12-13
C6	Fill of ditch	Sole fill of ditch C4, sealed by topsoil C2, it consisted of reddish-brown sandy clay with frequent small stones with rare charcoal flecks	3	Min. 14.2 (l) 1.7 (w) 0.35 (d)	C4		Figs 5, 6, 20	Plate 5

Context	Type	Description	Trench	Measurements (m)	Associated Cut / Fill	Samples	Figures	Plates
C7	Fill of ditch	Sole fill of ditch C5. Fill C7 consisted of dark greyish brown sandy clay with frequent charcoal and slag inclusions and large flat stones at the base. Slag/vitrified material retrieved – Sample 1	4	0.8-1 (w) 0.34 (d)	C5	1 (slag)	Figure 7, 20	Plates 12-13
C8	Cut of pit	Cut of oval pit, similar to pit C52 in Test Trench 1. Filled by C30 dark greyish black sandy clay with frequent inclusions of charcoal and small to medium fire-cracked stones.	2	0.97 x 0.75	C30		Figure 20	Plates 5-6
C9	Cut posthole	Cut of poss. post hole. Filled by C31 mid brownish-grey sandy clay with charcoal inclusions.	2	0.4 x 0.2	C31		Figure 8	Plates 5-6
C10	Cut of posthole	Cut of a poss. small posthole. Filled by C32 mid brownish-grey sandy clay with charcoal inclusions.	2	0.2 \emptyset	C32		Figure 8	Plates 5-6
C11	Cut of posthole	Cut of a poss. small posthole. Filled by C33 mid-brownish-grey sandy clay with charcoal inclusions.	2	0.25 \emptyset	C33		Figure 8	Plates 5-6
C12	Cut of pit	Cut of a poss. pit. Filled by C34 mid-brownish-grey sandy clay with charcoal inclusions.	2	0.6 x 0.75	C34		Figure 8	Plates 5-6
C13	Cut of posthole	Cut of a poss. oval posthole. Filled by C35 mid-brownish-grey sandy clay with charcoal inclusions.	2	0.3 x 0.25	C35		Figure 8	Plates 5-6
C14	Cut of posthole	Cut of a poss. small posthole. Filled by C36 mid-brownish-grey sandy clay with charcoal inclusions.	2	0.35 \emptyset	C36		Figure 8	Plates 5-6
C15	Cut of posthole	Cut of a poss. small posthole. Filled by C37 mid-brownish-grey sandy clay with charcoal inclusions.	2	0.3 x 0.26	C37		Figure 8	Plates 5-6
C16	Cut of posthole	Cut of a poss. small posthole. Filled by C38 mid-brownish-grey sandy clay with charcoal inclusions.	2	0.3 \emptyset	C38		Figure 8	Plates 5-6

Context	Type	Description	Trench	Measurements (m)	Associated Cut / Fill	Samples	Figures	Plates
C17	Cut of pit	Cut of a poss. pit continues beyond the test trench. Filled by C39 mid-brownish-grey sandy clay with charcoal inclusions.	2	0.5 x 0.2	C39		Figure 8	Plates 5-6
C18	Cut of stake	Cut of a poss. stake. No remains of stake visible on surface. Filled by C40 mid-brownish-grey sandy clay with charcoal inclusions.	2	0.1 \emptyset	C40		Figure 8	Plates 5-6
C19	Cut of posthole	Cut of a poss. small posthole. Filled by C41 mid-brownish-grey sandy clay with charcoal inclusions.	2	0.2 x 0.17	C41		Figure 8	Plates 5-6
C20	Cut of posthole	Cut of a poss. small posthole. Filled by C42 mid-brownish-grey sandy clay with charcoal inclusions.	2	0.16 \emptyset	C42		Figure 8	Plates 5-6
C21	Cut of posthole	Cut of a poss. posthole. Filled by C43 mid-brownish-grey sandy clay with charcoal inclusions.	2	0.4 \emptyset	C43		Figure 8	Plates 5-6
C22	Cut of stake	Cut of a poss. stake. No remains of stake visible on surface. Filled by C44 mid-brownish-grey sandy clay with charcoal inclusions.	2	0.12 \emptyset	C44		Figure 8	Plates 5-6
C23	Cut of stake	Cut of a poss. stake. No remains of stake visible on surface. Filled by C45 mid-brownish-grey sandy clay with charcoal inclusions.	2	0.1 \emptyset	C45		Figure 8	Plates 5-6
C24	Cut of posthole	Cut of a poss. posthole. Filled by C46 mid-brownish-grey sandy clay with charcoal inclusions.	2	0.38 \emptyset	C46		Figure 8	Plates 5-6
C25	Cut of ditch	Cut of linear ditch, northeast-southwest aligned, on same alignment as C53 and C55. Cut east slope was steep, south more gradual, filled by C 47 mid-brownish-grey silty clay with charcoal and basal fill C62 brownish grey silty sand with frequent inclusions of small stones.	2	2.3 (w) 0.73 (d)	C47, C62		Figure 8, 20	Plates 5-6

Context	Type	Description	Trench	Measurements (m)	Associated Cut / Fill	Samples	Figures	Plates
C26	Cut of pit	Cut of poss. pit, cut into C2, truncated by furrow C27. Partially exposed. Filled by C48 mid-brownish-grey sandy clay. Might account for anomaly labelled as trend by Target.	2	1.2 (l), 0.6(w)	C48		Figure 8	Plates 5-6
C27	Cut of furrow	Cut of a furrow, northeast-southwest aligned, same as C29, filled by C49 mid-brownish-grey sandy clay	2	0.4 (w), 0.05 (d)	C49		Figure 8	Plates 5-6
C28	Cut of pit	Cut of poss. pit, cut into C2, truncated by furrow C29. Partially exposed. Filled by C50 mid-brownish-grey sandy clay	2	1.4 (l), 0.6 (w)	C50		Figure 8	Plates 5-6
C29	Cut of furrow	Cut of a furrow, northeast-southwest aligned, same as C27, filled by C51 mid-brownish-grey sandy clay	2	0.4 (w) 0.05(d)	C51		Figure 8, 20	Plates 5-6
C30	Fill	Fill of poss. pit C8, it consisted of dark greyish black sandy clay with frequent inclusions of charcoal and small to medium fire cracked stones.	2	0.97 x 0.75	C8		Figure 8	Plates 5-6
C31	Fill	Fill of poss. posthole C9, it consisted of mid-brownish-grey sandy clay with charcoal inclusions.	2	0.4 x 0.2	C9		Figure 8	Plates 5-6
C32	Fill	Fill of poss. posthole C10, it consisted of mid-brownish-grey sandy clay with charcoal inclusions.	2	0.2ø	C10		Figure 8	Plates 5-6
C33	Fill	Fill of poss. posthole C11, it consisted of mid-brownish-grey sandy clay with charcoal inclusions.	2	0.25ø	C11		Figure 8	Plates 5-6
C34	Fill	Fill of poss. pit C12, it consisted of mid-brownish-grey sandy clay with charcoal inclusions.	2	0.6 x 0.75	C12		Figure 8	Plates 5-6
C35	Fill	Fill of poss. posthole C13, it consisted of mid-brownish-grey sandy clay with charcoal inclusions.	2	0.3 x 0.25	C13		Figure 8	Plates 5-6

Context	Type	Description	Trench	Measurements (m)	Associated Cut / Fill	Samples	Figures	Plates
C36	Fill	Fill of poss. posthole C14, it consisted of mid-brownish-grey sandy clay with charcoal inclusions.	2	0.35ø	C14		Figure 8	Plates 5-6
C37	Fill	Fill of poss. posthole C15, it consisted of mid-brownish-grey sandy clay with charcoal inclusions.	2	0.3 x 0.26	C15		Figure 8	Plates 5-6
C38	Fill	Fill of poss. posthole C16, it consisted of mid-brownish-grey sandy clay with charcoal inclusions.	2	0.3ø	C16		Figure 8	Plates 5-6
C39	Fill	Fill of poss. pit C17, it consisted of mid-brownish-grey sandy clay with charcoal inclusions.	2	0.5 x 0.2	C17		Figure 8	Plates 5-6
C40	Fill	Fill of poss. stakehole C18, it consisted of mid-brownish-grey sandy clay with charcoal inclusions.	2	0.1ø	C18		Figure 8	Plates 5-6
C41	Fill	Fill of poss. posthole C19, it consisted of mid-brownish-grey sandy clay with charcoal inclusions.	2	0.2 x 0.17	C19		Figure 8	Plates 5-6
C42	Fill	Fill of poss. posthole C20, it consisted of mid-brownish-grey sandy clay with charcoal inclusions.	2	0.16 ø	C20		Figure 8	Plates 5-6
C43	Fill	Fill of poss. posthole C21, it consisted of mid-brownish-grey sandy clay with charcoal inclusions.	2	0.4 ø	C21		Figure 8	Plates 5-6
C44	Fill	Fill of poss. stakehole C22, it consisted of mid-brownish-grey sandy clay with charcoal inclusions.	2	0.12 ø	C22		Figure 8	Plates 5-6
C45	Fill	Fill of poss. stakehole C23, it consisted of mid-brownish-grey sandy clay with charcoal inclusions.	2	0.1 ø	C23		Figure 8	Plates 5-6
C46	Fill	Fill of poss. posthole C24, it consisted of mid-brownish-grey sandy clay with charcoal inclusions.	2	0.38 ø	C24		Figure 8	Plates 5-6

Context	Type	Description	Trench	Measurements (m)	Associated Cut / Fill	Samples	Figures	Plates
C47	Fill	Top fill of ditch C25, sealing basal fill C62. C47 consisted of mid-brownish-grey silty clay with charcoal.	2	2.3 (w) 0.33 (d)	C25, C62		Figure 8, 20	Plates 5-6
C48	Fill	Fill of poss. pit C26, it consisted of mid-brownish-grey sandy clay	2	1.2 (l) 0.6(w)	C26		Figure 8	Plates 5-6
C49	Fill	Fill of furrow C27, it consisted of mid-brownish-grey sandy clay	2	1.2 (l) 0.6(w)	C27		Figure 8	Plates 5-6
C50	Fill	Fill of poss. pit C28, it consisted of mid-brownish-grey sandy clay	2	0.4 (w) 0.05 (d)	C28		Figure 8	Plates 5-6
C51	Fill	Fill of furrow C29, it consisted of mid-brownish-grey sandy clay	2	1.4 (l) 0.6 (w)	C29		Figure 8, 20	Plates 5-6
C52	Cut of pit	Cut of oval pit, similar to pit C8 in Test Trench 2. Filled by C54 dark greyish black sandy clay with frequent inclusions of charcoal and small to medium fire cracked stones.	1	0.9 x 0.8	C54		Figure 7, 20	Plates 2-4
C53	Cut of linear	Cut of linear C53, north-south aligned, exposed under poss. bank C94. On same alignment as C25 and C55. Filled by C95 pale brownish grey sandy clay, sterile looking.	1	0.4 (w)	C95		Figure 7	Plate 2
C54	Fill	Fill of oval pit C52, it consisted of dark greyish black sandy clay with frequent inclusions of charcoal and small to medium fire cracked stones. Soil sample taken.	1	0.9 x 0.8	C52	S2, soil sample, processed charcoal	Figure 7, 20	Plates 2-4
C55	Cut of linear	Cut of poss. linear north-south aligned, on same alignment as C25 and C53. It was filled by C96. Accounts for anomaly depicted as trend by Target	5	1.2-1.3 (w)	C96		Figure 8 10	Plate 6-8

Context	Type	Description	Trench	Measurements (m)	Associated Cut / Fill	Samples	Figures	Plates
C56	Cut of linear	Cut of poss. linear, only partially exposed in the east extent of Test Trench 6, it was filled by C61 mid-brownish-grey sandy clay	6	2.5 (w)	C61		Figure 10	Plate 15
C57	Cut of linear	Cut of poss. linear northwest-southeast aligned, filed by C59 pinkish grey silt. Accounts for anomaly depicted as trend by Target.	6	2.3 (w)	C59		Figure 10	Plate 17
C58	Cut of pit	Cut of pit, only partially exposed. Filled with C60 pale greyish brown silty sand, sterile in nature.	6	0.8 (l) 0.46 (w) 0.25 (d)	C60		Figure 10	Plate 18
C59	Fill	Fill of linear C57. C59 consisted of pinkish grey silt, sterile looking, with stony natural looking outcrop along its east extent	6	2.3 (w)	C57		Figure 10	Plate 17
C60	Fill	Fill of pit C58, C60 pale greyish brown silty sand, sterile in nature.	6	0.8 (l) 0.46 (w) 0.25 (d)	C58		Figure 10	Plate 18
C61	Fill	Fill of poss. linear C56. C61 consisted of mid-brownish-grey sandy clay	6		C56		Figure 10	Plate 15
C62	Fill	Basal fill of ditch C25. Sealed by C47. C62 consisted of brownish grey silty sand with frequent inclusions of small stones.	6	0.40m (d) 1.3 (w)	C25, C47		Figure 10, 20	Plates 5-6
C63	Cut of ditch	Cut of linear, east -west aligned, filled by C66 brownish grey stony clay. May represent a former field boundary. Accounts for anomaly labelled as field boundary. No boundaries on Ordnance Survey Map depicted, however it is parallel with the field boundaries in the area, might represent part of minor field system.	11	1.6 (w)	C66		Figure 12	Plate 25, 26

Context	Type	Description	Trench	Measurements (m)	Associated Cut / Fill	Samples	Figures	Plates
C64	Cut of ditch	<p>Cut of linear, east -west aligned, visible as a depression measuring c. 2.2m outside the test trench, filled by C65 brownish grey stony clay.</p> <p>Accounts for anomaly Target labelled as field boundary. The ditch aligns with the field boundary shown on the 1st Edition Ordnance Survey Map of 1840 (Figure 2). It is therefore assumed to be of 19th-century date and not of archaeological significance.</p>	10	1.4 (w) 0.2 (d)	C65		Figure 12	Plate 23
C65	Fill	Fill of linear C64, C65 consisted of pinkish grey sandy clay	10	1.4 (w) 0.2 (d)	C64		Figure 12	Plate 23
C66	Fill	Fill of linear C63, brownish grey stony clay.	11	1.6	C63		Figure 12	Plate 25, 26
C67	Cut of ditch	<p>Cut of poss. ditch, northwest southeast aligned, visible as a depression outside the test trench. Filled by C71, dark grey sandy clay.</p> <p>Aligned with anomaly labelled as trend by Target, it aligns with field boundary depicted on the 1st Edition Ordnance Survey Map 1840. It is therefore assumed to be of 19th-century date and not of archaeological significance.</p>	14	2.5 (w) 0.4 (d)	C71		Figure 14, 21	Plate 32
C68	Cut of ditch	Cut of poss. ditch, northwest southeast aligned. Filled by C72, pale grey sandy clay with charcoal and patches of orange sand.	14	0.4 (w)	C72		Figure 14	Plate 33
C69	Cut of ditch	Cut of poss. ditch, northwest southeast aligned. Filled by C73, pale grey sandy clay with charcoal and patches of orange sand.	14	0.6 (w)	C73		Figure 14	Plate 33
C70	Spread	<p>Spread in a form of raised area, exposed in the south end of Test Trench 14. Spread was mid grey sandy clay with charcoal and medium size stone inclusions, a poss. linear (C129) running northeast-southwest was exposed measuring 0.24m in width and 0.1m in depth.</p>	14	Min. 3m (l) 0.20 (d)	-		Figure 14, 21	Plate 33, 35

Context	Type	Description	Trench	Measurements (m)	Associated Cut / Fill	Samples	Figures	Plates
C71	Fill	Fill of linear C67. C71 dark grey sandy clay.	14	2.5 (w) 0.4 (d)	C67		Figure 14, 21	Plate 32
C72	Fill	Fill of linear C68. C72 consisted of pale grey sandy clay with charcoal and patches of orange sand.	14	0.4 (w)	C68		Figure 14	Plate 33
C73	fill	Fill of linear C69. C73 consisted of mid grey sandy clay with charcoal. Slag/vitrified material was retrieved.	14	0.6 (w)	C69		Figure 14	Plate 33
C74	Cut of linear	Cut of linear, east-west aligned, gradual slope, round base, filled by C77 sterile orangish brown clay with frequent small stones at the base. Accounts for anomaly labelled as field boundary by Target. The ditch aligns with the field boundary shown on the 1st Edition Ordnance Survey Map of 1840. It is therefore assumed to be of 19th-century date and not of archaeological significance.	13	1.5 (w) 0.5 (d)	C77		Figure 13, 20	Plate 30
C75	Cut of linear	Cut of linear, east-west aligned, cut by C76. Cut had steep sides and round base. It was filled by C79 sterile whitish grey sand.	13	0.48 (w) 0.35 (d)	C79		Figure 13, 20	Plate 31
C76	Cut of linear	Cut of linear, truncating C75. Filled by C78 mid grey silty sand.	13	0.6 (w)	C78		Figure 13	Plate 29
C77	Fill	Fill of linear C74. C77 consisted of sterile orangish brown clay with frequent small stone at the base.	13	1.5 (w) 0.5 (d)	C74		Figure 13, 20	Plate 30
C78	Fill	Fill of linear C76. C78 consisted of mid grey silty sand.	13	0.6 (w)	C76		Figure 13	Plate 29
C79	Fill	Fill of linear C75. C79 consisted of sterile whitish grey sand.	13	0.48 (w) 0.35 (d)	C75		Figure 13, 20	Plate 31

Context	Type	Description	Trench	Measurements (m)	Associated Cut / Fill	Samples	Figures	Plates
C80	Cut of linear	Cut of linear, east-west aligned, filled by C82 sterile grey silty clay with small stone inclusions. Aligned with east west anomaly labelled as trend by target.	12	1.7 (w)	C82		Figure 13	Plate 28
C81	Cut of linear	Cut of linear, east-west aligned, filled by C83 sterile grey silty clay with decaying stone inclusions. Accounts for anomaly labelled as field boundary by Target. The ditch aligns with the field boundary shown on the 1st Edition Ordnance Survey Map of 1840 (Figure 2). It is therefore assumed to be of 19th-century date and not of archaeological significance.	12	1.3 (w)	C83		Figure 13	Plate 27
C82	Fill	Fill of linear C80. C82 consisted of sterile grey silty clay with small stone inclusions.	12	1.7 (w)	C80		Figure 13	Plate 28
C83	Fill	Fill of linear C81. C83 consisted of sterile grey silty clay with decaying stone inclusions.	12	1.3 (w)	C81		Figure 13	Plate 27
C84	Cut of pit	Cut of oval pit, partially exposed. South side steep, north more gradual. Filled by C90 brownish grey sandy clay with inclusions of charcoal, small to medium stones and decaying stones. Accounts for Anomaly 15, that represented a series of anomalies interpreted as ?Archaeology – probable burnt/fired deposit	15	1.4 (l) 1.1 (w) 0.15 (d)	C90		Figure 15, 21	Plate 38, 40
C85	Cut of linear	Cut of linear, northeast southwest aligned, filled by top fill C91 pale greyish brown sandy clay with stones, charcoal and some slag, sealing C97 dark greyish brown sandy clay with frequent inclusions of slag and charcoal. Accounts for Anomaly 15, that represented a series of anomalies interpreted as ?Archaeology – probable burnt/fired deposit	15	0.55 (w) 0.34 (d)	C91, C97	5	Figure 15, 21	Plate 38, 39

Context	Type	Description	Trench	Measurements (m)	Associated Cut / Fill	Samples	Figures	Plates
C86	Spread	Spread, partially exposed, extending west, dark blackish brown sandy clay, with frequent inclusions of charcoal, small to medium head shattered stones. Accounts for Anomaly 15, that represented a series of anomalies interpreted as ?Archaeology – probable burnt/fired deposit	15	1 (l) 1 (w)	-		Figure 15	Plate 37
C87	Cut of linear	Cut of poss. linear northeast southwest aligned, filled by C93 brownish grey sandy clay with inclusions of charcoal, small to medium stones. Accounts for Anomaly 15, that represented a series of anomalies interpreted as ?Archaeology – probable burnt/fired deposit	15	1.2 (w)	C93		Figure 15	Plate 37
C88	Spread	Poss. spread, partially exposed, mid blackish brown sandy clay, with frequent inclusions of charcoal and small to medium head shattered stones. Accounts for Anomaly 15, that represented a series of anomalies interpreted as ?Archaeology – probable burnt/fired deposit	15	6.5 (l)	-		Figure 15	Plate 37
C89	Spread	Poss. spread, partially exposed, dark blackish brown sandy clay, with frequent inclusions of charcoal, slag and small to medium head shattered stones. Slag sampled. Accounts for Anomaly 15, that represented a series of anomalies interpreted as ?Archaeology – probable burnt/fired deposit	15	Min. 3.5 (m)	-	4	Figure 15	Plate 37
C90	Fill	Fill of pit C84. C90 consisted of brownish grey sandy clay with inclusions of charcoal, small to medium stones and decaying stones.	15	1.4 (l) 1.1 (w) 0.15 (d)	C84		Figure 15, 21	Plate 38, 40
C91	Fill	Top fill of linear C85, sealing basal fill C97. C91 consisted of pale greyish brown sandy clay with stones, charcoal and some slag.	15	0.15 (d)	C85, C97		Figure 15, 21	Plate 38, 39
C92	Fill	Fill of ditch C3. C92 consisted of pale greyish brown sandy clay.	9	1.2 (w) 0.25 (d)	C3		Figure 11	Plate 21, 22

Context	Type	Description	Trench	Measurements (m)	Associated Cut / Fill	Samples	Figures	Plates
C93	Fill	Fill of linear C87. C93 consist of brownish grey sandy clay with inclusions of charcoal, small to medium stones.	15	1.2 (w)	C87		Figure 15	Plate 37
C94	Bank	Poss. bank. Exposed in east part of Test Trench 1. Following its removal linear C53 was exposed. This bank consisted of mid-brownish-grey sandy clay.	1	2.1 (w) 0.1 (d)	-		Figure 7	Plate 2
C95	Fill	Fill of linear C53, sealed by poss. bank C94. C95 consisted of pale brownish grey sandy clay, sterile looking.	1	0.4 (w)	C53		Figure 7	Plate 2
C96	Fill	Fill of linear C55. C96 was pale mid brown grey sandy clay.	5	1.2-1.3 (w)	C55		Figure 15	Plates 6-8
C97	Fill	Basal fill of linear C85, sealed by C91. C97 consisted of dark greyish brown sandy clay with frequent inclusions of slag and charcoal. Slag sampled	15	0.9 (w) 0.21 (d)	C85, C91	5	Figure 15, 21	Plate 38, 39
C98	Cut of linear	Cut of linear, northwest southeast aligned, filled by C100 pale grey silty clay Accounts for Anomaly 12 by AMS. Part of an old field system of unknown date.	20	0.7 (w)	C100		Figure 19	Plate 56
C99	Cut of ditch	Cut of ditch, east west aligned, filled by top fill C101 and basal fill C111. Accounts for Anomaly 1 by AMS. Part of an old field system of unknown date.	20	2.3 (w) 1.4 (d)	C101, C111		Figure 19, 22	Plate 54-55
C100	Fill	Fill of linear C98. C100 consist of pale grey silty clay.	20	0.7	C98		Figure 19	Plate 56
C101	Fill	Top fill of C99, sealing basal fill C111. C101 consist of mid grey brown sandy clay.	20	2.3 (w) 0.4m (d)	C99, C111		Figure 19, 22	Plate 54-55

Context	Type	Description	Trench	Measurements (m)	Associated Cut / Fill	Samples	Figures	Plates
C102	Cut of ditch	Cut of ditch, east west aligned, same as C108 exposed in Test Trench 18. Filled by C104 greyish brown sandy clay with inclusions of small stones. Accounts for Anomaly 15 by AMS. This ditch aligns with field boundary shown on 1st Edition Ordnance Survey Map of 1840 (Figure).	19	1.5 (w)	C104		Figure 18	Plate 52
C103	Spread	Spread, partially exposed, stone and charcoal.	19	2 (l)	-		Figure 18	Plate 52
C104	Fill	Fill of ditch C102. C104 consists of greyish brown sandy clay with inclusions of small stones.	19	1.5 (w)	C102		Figure 18	Plate 52
C105	Fill	Fill of linear C108. C105 consist of greyish brown sandy clay with inclusions of small stones.	18	1.5 (w)	C108		Figure 18	Plate 49
C106	Spread	Spread of charcoal, stone and clay, partially exposed.	18	3 (l)	-		Figure 18	Plate 51
C107	Cut of linear	Cut of linear/ditch, north south aligned filled by C109 brownish grey sandy clay sealing C110 and charcoal rich dark brownish grey sandy clay. Accounts for Anomaly 5 by AMS. This ditch is parallel and west of field boundary visible in the 1 st Edition Ordnance Survey Map of 1840 (Figure), it may represent part of old field system.	18	1.2 (w)	C109, C110		Figure 18	Plate 49-50
C108	Cut of ditch	Cut of ditch, east west aligned, same as C102 exposed in Test Trench 19. Filled by C105 greyish brown sandy clay with inclusions of small stones. Accounts for Anomaly 15 by AMS. This ditch aligns with field boundary shown on 1st Edition Ordnance Survey Map of 1840 (Figure).	18	1.5 (w)	C105		Figure 18	Plate 49
C109	Fill	Top fill of ditch C107 sealing basal fill C110. C109 consisted of brownish grey sandy clay.	18	1.2 (w)	C107		Figure 18	Plate 49-50

Context	Type	Description	Trench	Measurements (m)	Associated Cut / Fill	Samples	Figures	Plates
C110	Fill	Basal fill of ditch C110, sealed by C109. C110 consisted of charcoal rich dark brownish grey sandy clay.	18	1.2 (w)	C110, C109		Figure 18	Plate 49-50
C111	Fill	Basal fill of ditch C99, sealed by C101. C111 consists of greyish blue clay with frequent stone inclusions.	20	0.4	C99, C101		Figure 19, 22	Plate 54-55
C112	Cut of linear	Cut of linear, east west aligned, filled with C117, C118, C119, very sterile material. Accounts for Anomaly 8 by AMS. Part of field system of unknown date.	16	1.8 (w) 0.83 (d)	C117, C118, C119	6, 8	Figure 16, 22	Plate 43
C113	Cut of linear	Cut of linear, east west aligned, filled with C126 very sterile pale greyish brown sandy clay.	16	1.8 (w) 0.1 (d)	C126		Figure 16, 21	Plate 44
C114	Cut of linear	Cut of linear, east west aligned, filled with C127 very sterile pale greyish brown sandy clay.	16	0.5	C127		Figure 16	Plate 41
C115	Cut of linear	Cut of linear, east west aligned, filled with C120 very sterile pale greyish brown sandy clay. Accounts for Anomaly 9 by AMS.	16	1.65 (w) 0.45 (d)	C120		Figure 16, 21	Plate 45
C116	Cut of linear	Cut of linear, east west aligned, filled with base fill C128 and top fill C125. Accounts for Anomaly 16 by AMS, interpreted as Feature on early OS mapping. The ditch aligns with the field boundary shown on the 3rd Edition Ordnance Survey Map of 1903 (Figure 2). It is therefore assumed to be of 20th-century date and not of archaeological significance.	16	2 (w) 1.2 (d)	C120, C125	7	Figure 16, 22	Plate 42
C117	Fill	Top fill of linear C112, sealing C118. C117 consisted of pale brownish grey sandy clay.	16	0.18 (d)	C112, C118, C119		Figure 16, 22	Plate 43

Context	Type	Description	Trench	Measurements (m)	Associated Cut / Fill	Samples	Figures	Plates
C118	Fill	Fill of linear C112, sealed by top fill C117, sealing basal fill C119. C118 consisted of mid-brownish-grey sandy clay	16	0.4 (d)	C112, C117, C119	6	Figure 16, 22	Plate 43
C119	Fill	Basal fill of linear C112, sealed by C 118. C119 consisted of dark brownish grey sandy clay with inclusions of small to medium size stones.	16	0.3 (d)	C112, C117, C118	8	Figure 16, 22	Plate 43
C120	Fill	Fill of linear C115. C128 consisted of very sterile pale greyish brown sandy clay.	16	1.65 (w) 0.45 (d)	DC116, C125	7	Figure 16, 21	Plate 45
C121	Cut of ditch	Cut of ditch, north south aligned, similar and parallel to linear C122. Filled by C123 greyish brown sandy clay Accounts for Anomaly 6 by AMS. This ditch is parallel with field boundary shown on 1st Edition Ordnance Survey Map of 1840 (Figure). It likely associated with the boundary and represent a ditch.	17	1 (w) 0.2 (d)	C122		Figure 17, 22	Plate 47
C122	Cut of ditch	Cut of ditch, north south aligned, similar and parallel to linear C121. Filled by C124 greyish brown sandy clay. Accounts for Anomaly 4 by AMS. This ditch is parallel with field boundary shown on 1st Edition Ordnance Survey Map of 1840 (Figure). It likely is associated with the boundary and represents a ditch.	17	2 (w) 0.33 (d)	C124		Figure 17, 22	Plate 48
C123	Fill	Fill of C121. C123 consisted of greyish brown sandy clay	17	1 (w) 0.2 (d)	C123		Figure 17	Plate 47
C124	Fill	Fill of C122. C124 consisted of greyish brown sandy clay.	17	2 (w) 0.33 (d)	C122		Figure 17	Plate 48
C125	Fill	Top fill of C116, sealing basal fill C128. C125 pale grey sandy clay.	16	1.5 (w) 0.2 (d)	C120		Figure 16	Plate 42

Context	Type	Description	Trench	Measurements (m)	Associated Cut / Fill	Samples	Figures	Plates
C126	Fill	Fill of linear C113. C126 consisted of very sterile pale greyish brown sandy clay.	16	1.8 (w) 0.1 (d)	C113		Figure 16, 21	Plate 44
C127	Fill	Fill of linear C114. C127 consisted of very sterile pale greyish brown sandy clay.	16	0.5	C114		Figure 16	Plate 41
C128	Fill	Basal fill of C116 sealed by C125. C128 consisted brownish grey clay with frequent inclusions of loose medium size stones.	16	1.2 (d)	C128		Figure 16, 22	Plate 42
C129	Cut	Cut of northeast-southwest aligned linear exposed under spread C70. Filled by C130 dark grey sandy clay with charcoal and medium size stone inclusions.	14	Min. 3.3m (l) 0.24m (w) 0.1 (d)	C130		Figure 14, 21	Plate 33, 35
C130	Fill	Fill of linear C129, sealed by spread C70. C130 consisted of dark grey sandy clay with charcoal and medium size stone inclusions.	14	Min. 3.3m (l) 0.24m (w) 0.1 (d)	C129		Figure 14, 21	Plate 33, 35

Table 9: Inventory of features

11. BIBLIOGRAPHY

- Aalen, F H A, Whelan, K & Stout, M 1997 Atlas of the Irish Rural Landscape: Early Rural Landscapes from Prehistory to Plantation. Cork University Press, Cork.
- Binchy, D A 1962 'The old name of Charleville, Co. Cork', *Éigse*, Vol.10, No. 3, 211–235.
- Code of Practice between the Department of the Department of Arts, Heritage and the Gaeltacht and Iarnród Éireann (2012).
- Corlett, C & Potterton, M (eds) 2011 Settlement in Early Medieval Ireland in the light of recent archaeological excavations. Wordwell Ltd, Dublin.
- Corlett, C & Potterton, M (eds) 2012 Life and Death in Iron Age Ireland in the light of recent archaeological excavations. Wordwell Ltd, Dublin.
- Doody, M 2008 The Ballyhoura Hills Project. Discovery Programme Monograph No. 7. Wordwell Ltd, Bray.
- Dowling, G. 2020. Geophysical Survey Report of Lands at Ballynageragh & Imphrick, Co. Cork (20R0016). Unpublished report prepared by AMS on behalf of Jacobs Engineering.
- FitzPatrick, E 2009. 'Native enclosed settlement and the problem of the Irish 'Ring-fort'', *Medieval Archaeology*, Vol. 53, No. 1, 271–307.
- Flynn, C 2011 Archaeological Desk Based Assessment for XC219, XC215 & XC209 Level Crossings, Co. Cork and XC201 & XC187 Level Crossings, Co. Limerick. Unpublished report prepared by Valerie J. Keeley Ltd for Roughan & O'Donovan/Iarnród Éireann.
- Gowen, M 1988 Three Irish Gas Pipelines: New Archaeological Evidence in Munster. Wordwell Ltd, Dublin.
- Hawkes, A 2018 The Archaeology of Burnt Mounds in Ireland. Archaeopress, Oxford.
- Institute of Archaeologists of Ireland (IAI) 2004. *The Treatment of Human Remains: Technical paper for Archaeologists*. IAI, Dublin.
- Institute of Archaeologists of Ireland (IAI). 2006a. *IAI Code of Conduct for the Treatment of Archaeological Objects in the context of an archaeological excavation*. Dublin: IAI. (<http://www.iai.ie/wp-content/uploads/2016/03/IAI-Code-of-Conduct-for-the-Treatment-of-Archaeological-Objects.pdf>, accessed November 2019).
- Institute of Archaeologists of Ireland (IAI) 2006b. *IAI Code of Conduct for the Archaeological Treatment of Human Remains in the context of an archaeological excavation*. IAI, Dublin.
- Institute of Archaeologists of Ireland (IAI). 2007. *Environmental Sampling: Guidelines for Archaeologists*. IAI, Dublin. (<http://www.iai.ie/wp-content/uploads/2016/03/EnvironmentalSamplingGuidelines-2007-comp-1.pdf>, accessed November 2019).
- Kerr, T., R., 2007 Early Christian Settlement in North-West Ulster. BAR British Series 430. Archaeopress, Oxford.
- McClatchie, M., O Carroll, E. & Murphy E. 2015. *TII Palaeo-Environmental Sampling Guidelines Retrieval, analysis and reporting of plant macro-remains, wood, charcoal, insects and pollen and insects from archaeological excavations Version 5*. Transport Infrastructure Ireland, Dublin.
- National Monuments Service. 2006. Guidelines for Authors of Reports on Archaeological Excavations. <https://www.archaeology.ie/sites/default/files/media/publications/excavation-reports-guidelines-for-authors.pdf>.

National Museum of Ireland (NMI). 2010. *Advice Notes for Excavators*. Dublin: NMI. (<https://www.museum.ie/NationalMuseumIreland/media/Corporate-Information/Policies%20and%20Guidelines/Advice-Notes-for-Excavators-2010.pdf>, accessed October 2018).

Nichols, J. 2020. Geophysical Survey Report XC211 (Ballynageragh & Imphrick Townland) & XC215 (Shinanagh Townland), Cork Line Level Crossing Project, County Cork (20R0016 & 20R0017). Unpublished report prepared by AMS Ltd. on behalf of Jacobs Engineering.

O'Sullivan, M, & Downey, L. 2006 'Holy Wells', *Archaeology Ireland*, Vol. 20, No. 1, 35–37.

O'Sullivan, A, McCormick, F, Kerr, T R & Harney, L. 2013 *Early Medieval Ireland AD 400–1100: The evidence from archaeological excavations*. Royal Irish Academy, Dublin.

Power, D, Lane, S, Byrne, E, Egan, U, Sleeman, M, Cotter, E & Monk, J. 2000 *Archaeological Inventory of County Cork Volume 4: North Cork*. The Stationery Office, Dublin.

Stout, M. 1997 *The Irish Ringfort*, Four Courts Press, Dublin.

Woodman, P C. 2015 *Ireland's First Settlers: Time and the Mesolithic*. Oxbow Books. Oxford.

11.1 Other Sources

Cork County Development Plan 2013-2019

2012 Code of Practice between the Department of the Department of Arts, Heritage and the Gaeltacht and Iarnród Éireann
<https://www.archaeology.ie/sites/default/files/media/publications/cop-iarnrod-eireann-en.pdf>

Geological Survey Ireland Spatial Resources

(<https://dcenr.maps.arcgis.com/apps/MapSeries/index.html?appid=a30af518e87a4c0ab2fbde2aaac3c228>, accessed November 2019).

<https://holywells-corkandkerry.com/gazeteer/>

Index to the Townlands and Towns, Parishes and Baronies of Ireland, Genealogical Publishing Company, 1851. (www.townlands.ie)

National Monuments Service Archaeological Survey Database (<http://webgis.archaeology.ie/historicenvironment/>).

Record of Monuments and Places (RMP), The Department of Arts, Heritage and the Gaeltacht, Custom House, Dublin 1.

Topographical Files of the National Museum of Ireland, Kildare Street, Dublin 2.

Summary Accounts of Archaeological Excavations in Ireland (www.excavations.ie).

11.2 Cartographic Sources

1840 Ordnance Survey first-edition six-inch map (www.map.geohive.ie/mapviewer.html, accessed February 2020).

1903–05 Ordnance Survey third-edition 25-inch maps (www.map.geohive.ie/mapviewer.html, accessed February 2020).

GeoHive Ordnance Survey mapping data (<http://map.geohive.ie/mapviewer.html>)

Ordnance Survey Ortho (aerial photography) series, 1995, 2000, 2005, 2013

12. EXCAVATIONS BULLETIN

Cork

Cork Line Level Crossing Project: XC215 Shinanagh: Ballynageragh & Imphrick, Ballyhea, Co. Cork

20E639 20R248

ITM 553605, 615358 (N) to 553465, 614494 (S)

Testing

18th – 25th November

A programme of Advance Targeted Archaeological Test Excavations was carried out in advance of the Cork Line Level Crossings Project: XC215 Shinanagh, Co. Cork in November 2020. The site is located within three large pasture fields, in the townland of Ballynageragh & Imphrick and its south extent is within the immediate environs of Church (CO007-120002-) with an associated Graveyard (CO007-120001-) and Ritual site – holy well (CO007-121----).

The work was carried out on behalf of Iarnród Éireann to help inform the preparation of an Environmental Impact Assessment Report for the preferred route. Prior to the archaeological testing a Geophysical (Fluxgate Gradiometer) survey (Dowling 2020) and high-resolution magnetic gradiometry (Nicholls 2020) was carried out under licence 20R0016. The anomalies identified in the course of geophysical survey of Field 1 were interpreted as associated with field divisions, while geophysical survey of Field 2 resulted in the identification of remnants of a probable field system/field divisions and archaeological remains in the south end of the field (Nicholls 2020). In Field 3 all anomalies identified represented linears, including two historical boundaries and features identified as representing old field systems that possibly relate to the monuments located in the immediate environs. The test excavation strategy was designed to target these anomalies to determine if they represented archaeological features.

The site was assessed by Ian Russell between the 18th and 25th November 2020. A total of 20 test trenches were excavated across the footprint of the site using a 14 tonne tracked excavator fitted with a 1.8m wide bucket. A total of 317m of linear test trench were excavated. Anomalies identified during the geophysical survey (20R0016) were targeted (Test Trenches 1-20). In general, the average thickness of the topsoil measured c. 0.3-0.6 m and consisted of greyish brown sandy clay exposing natural, that varied between greyish-yellow sandy clay and pale orange grey marl.

Three areas of archaeological activity were identified; in the north end of Field 1; in the south end of Field 2, and; within Field 3. In the north extent of Field 1 a number of features of archaeological significance were exposed and comprised pits, post-holes, linears and ditches, all suggestive of settlement/archaeological activity within the site. While the fills of the features did not contain any datable finds, slag and vitrified material was retrieved and samples were taken. The features located in the south end of Field 2 were identified during geophysical survey, and targeted test trenching confirmed their archaeological significance. The features exposed consisted of consisted of linears, pits, ditches and spreads associated with metalworking with slag/vitrified material retrieved from both – spreads and linears. In Field 3 a spread and a number of linears/ditches were exposed, while these did not produce any datable material, and their linear nature and sterile fills are suggestive of field systems of unknown date, the location is in the immediate environs of the Church (CO007-120002-); an associated Graveyard (CO007-120001-) and Ritual site – holy well (CO007-121----) therefore these may potentially be associated with the medieval landscape. Future, more extensive investigation will be required to determine their full extent and significance.

It appears that most of the remaining linear features identified throughout the site are consisted with anomalies identified in the geophysical survey and represent field divisions and/or former field boundaries as well as in some cases geological differences in the natural and/or changes in the topsoil, likely of recent date.

A number of environmental samples from the various features, including pit and ditch fills were taken on site. Some of these produced charcoal and it is recommended that a number of these be submitted for radiocarbon dating in order to better understand the nature and dating of the features exposed. As the proposed Cork Line Level Crossings Project will require significant ground works, all identified features will be directly impacted. Full preservation by record (i.e. archaeological excavation) in advance of construction works commencing will therefore be required in order to mitigate this permanent impact. The possible presence of other smaller archaeological features along this route in the un-tested areas can not be dismissed; therefore it is recommended that the area is subject to more general test trenching throughout the full land take area in advance of construction works commencing. The particulars of any mitigation measures will be included in the Environmental Impact Assessment Report for the scheme.

Ian Russell, Archaeological Consultancy Services Unit Ltd., 21 Boyne Business Park, Greenhills, Drogheda, Co. Louth

References:

Dowling, G. 2020. *Geophysical Survey Report of Lands at Ballynageragh & Imphrick, Co. Cork (20R0016)*. Unpublished report prepared by AMS on behalf of Jacobs Engineering.

Nicholls, J. 2020. Geophysical Survey Report XC211 (Ballynageragh & Imphrick Townland) & XC215 (Shinanagh Townland), Cork Line Level Crossing Project, County Cork (20R0016 & 20R0017). Unpublished report prepared by AMS Ltd. on behalf of Jacobs Engineering.

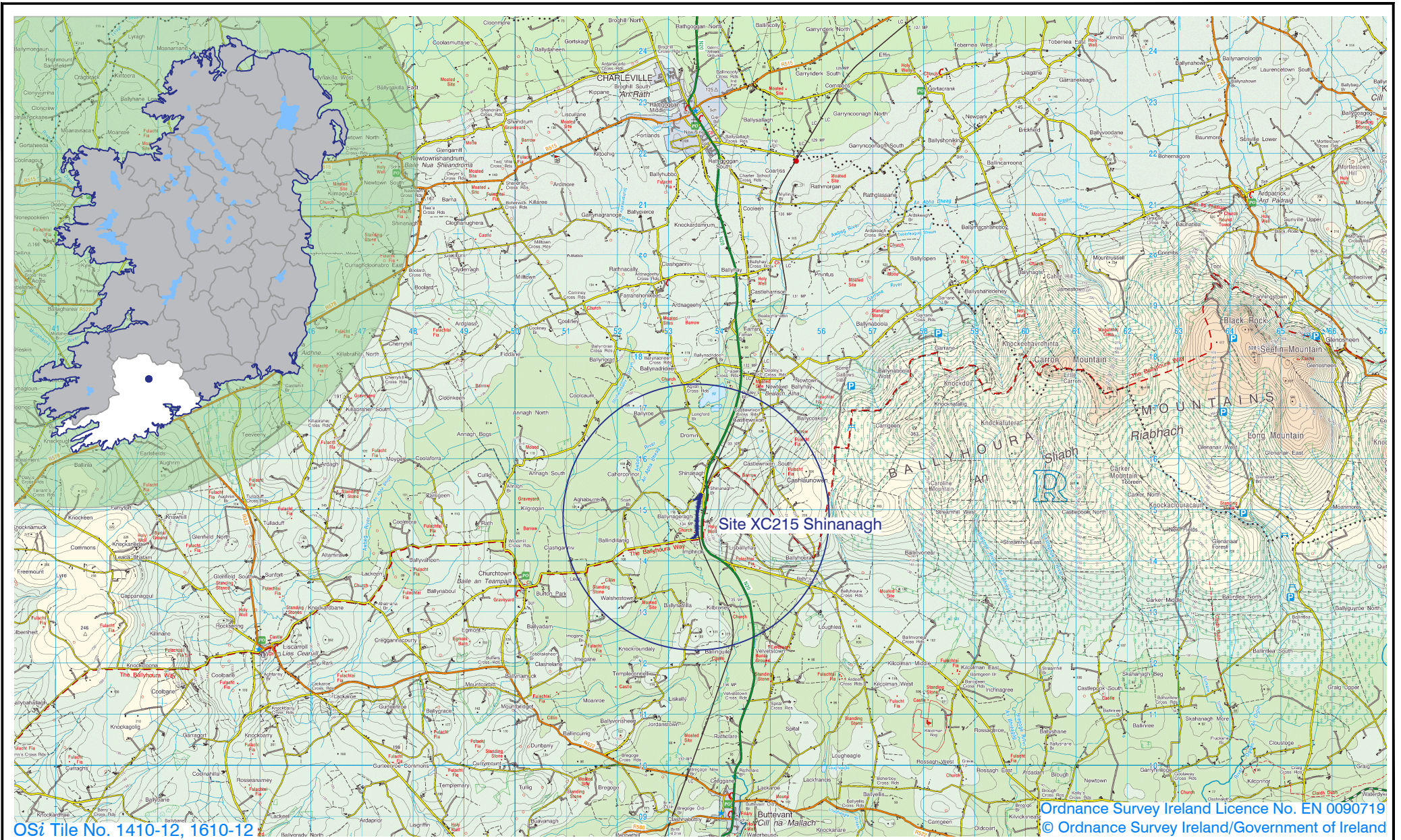

5 km



Archaeological Consultancy Services Unit **acsu.ie**



Site: Cork Line Level Crossings Project, Co. Cork/Limerick
 Issued for: Archaeological Test Trenching Report
 Drawing number: 2058_C1001
 Date: December 2020 | Scale: 1:100,000 @A4

Figure 1: Location of site

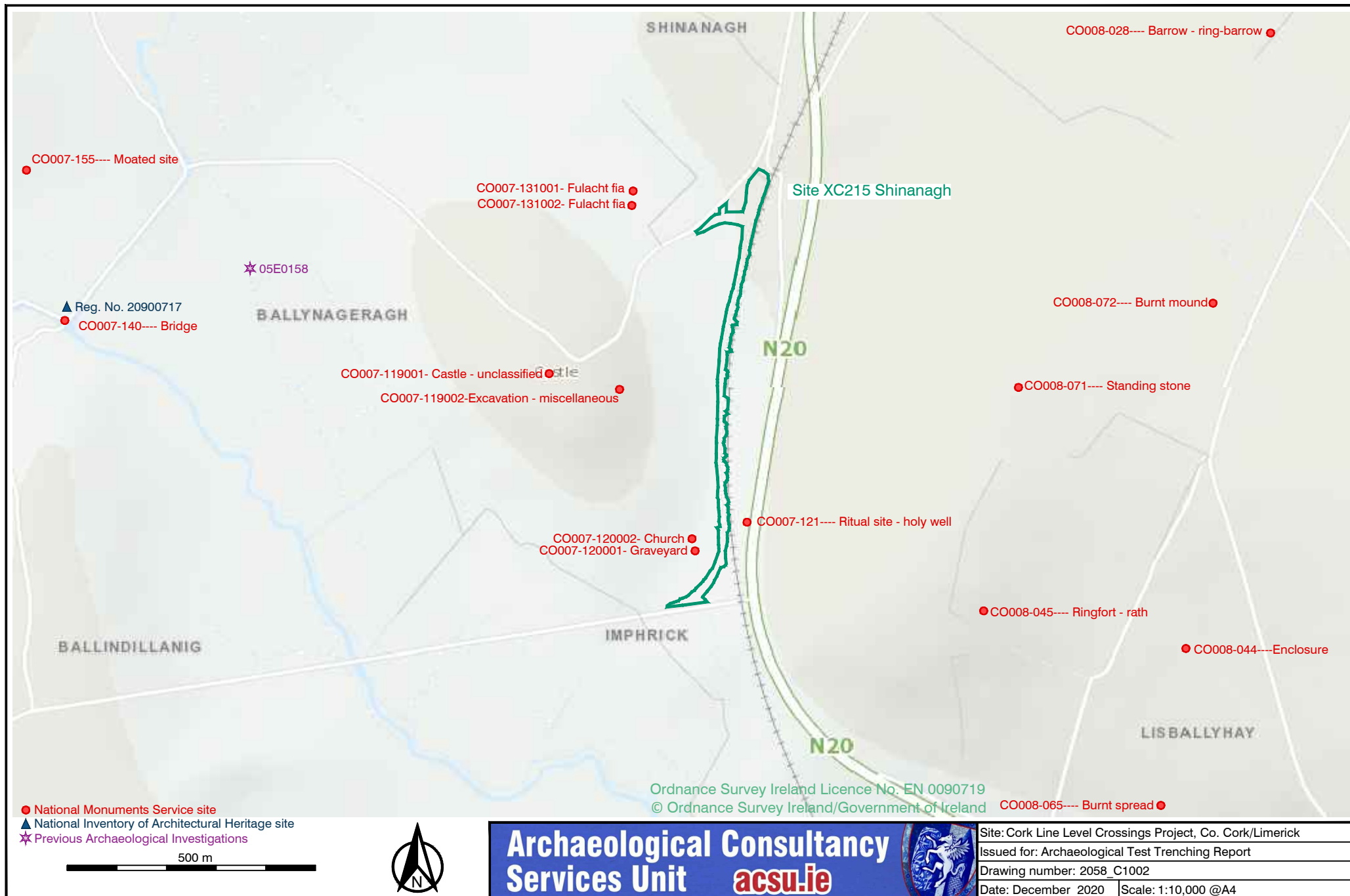
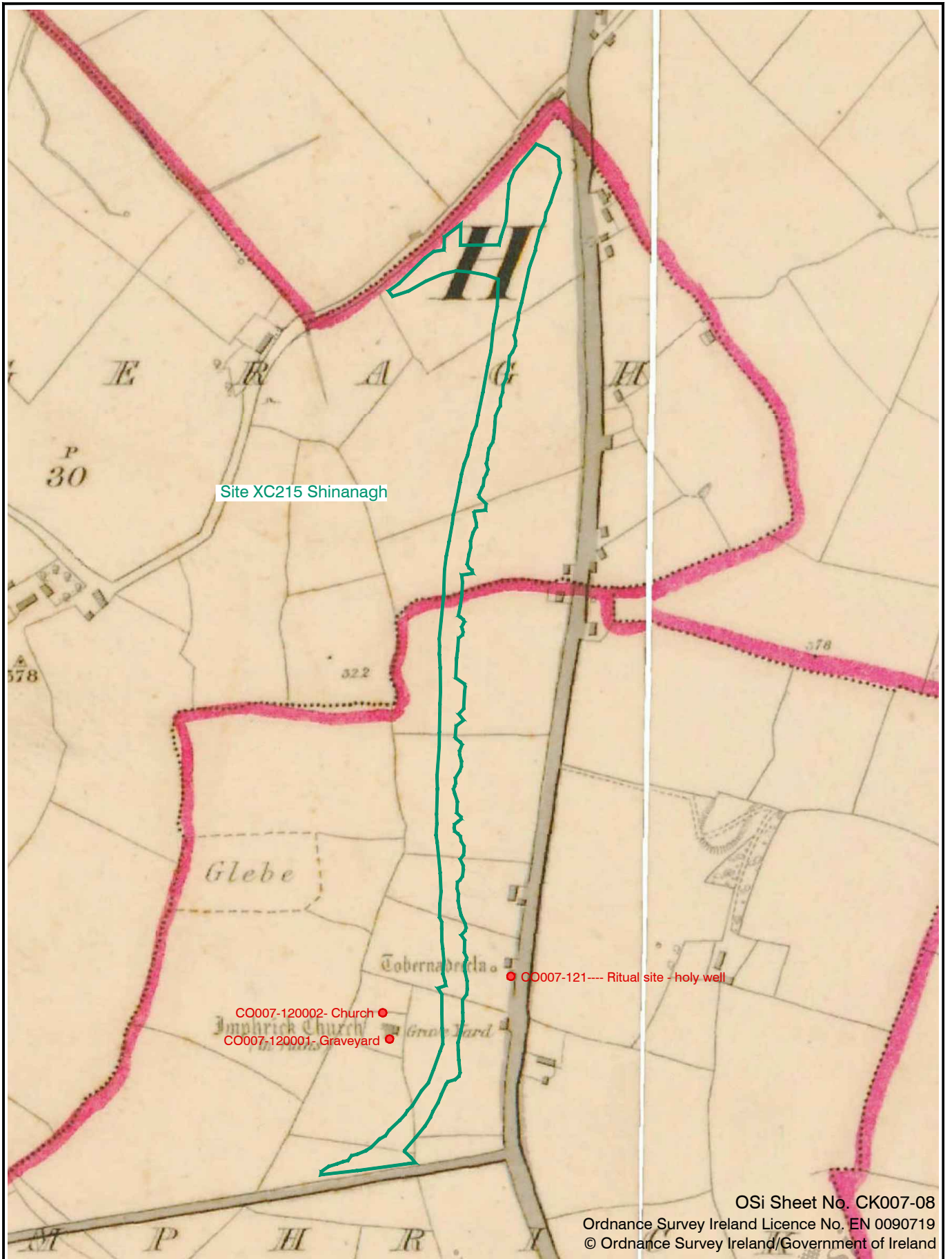

Figure 2: Location of site, previous archaeological investigations and nearby *Sites and Monuments Record* sites



200 m

● National Monuments Service site

Archaeological Consultancy Services Unit
acsu.ie



Site: Cork Line Level Crossings Project, Co. Cork/Limerick
 Issued for: Archaeological Test Trenching Report
 Drawing number: 2058_C1003
 Date: December 2020 | Scale: 1:4,500 @A4

Figure 3: Extract from 1st edition Ordnance Survey (OS) 6-inch map (surveyed 1840 - published 1844), showing location of site

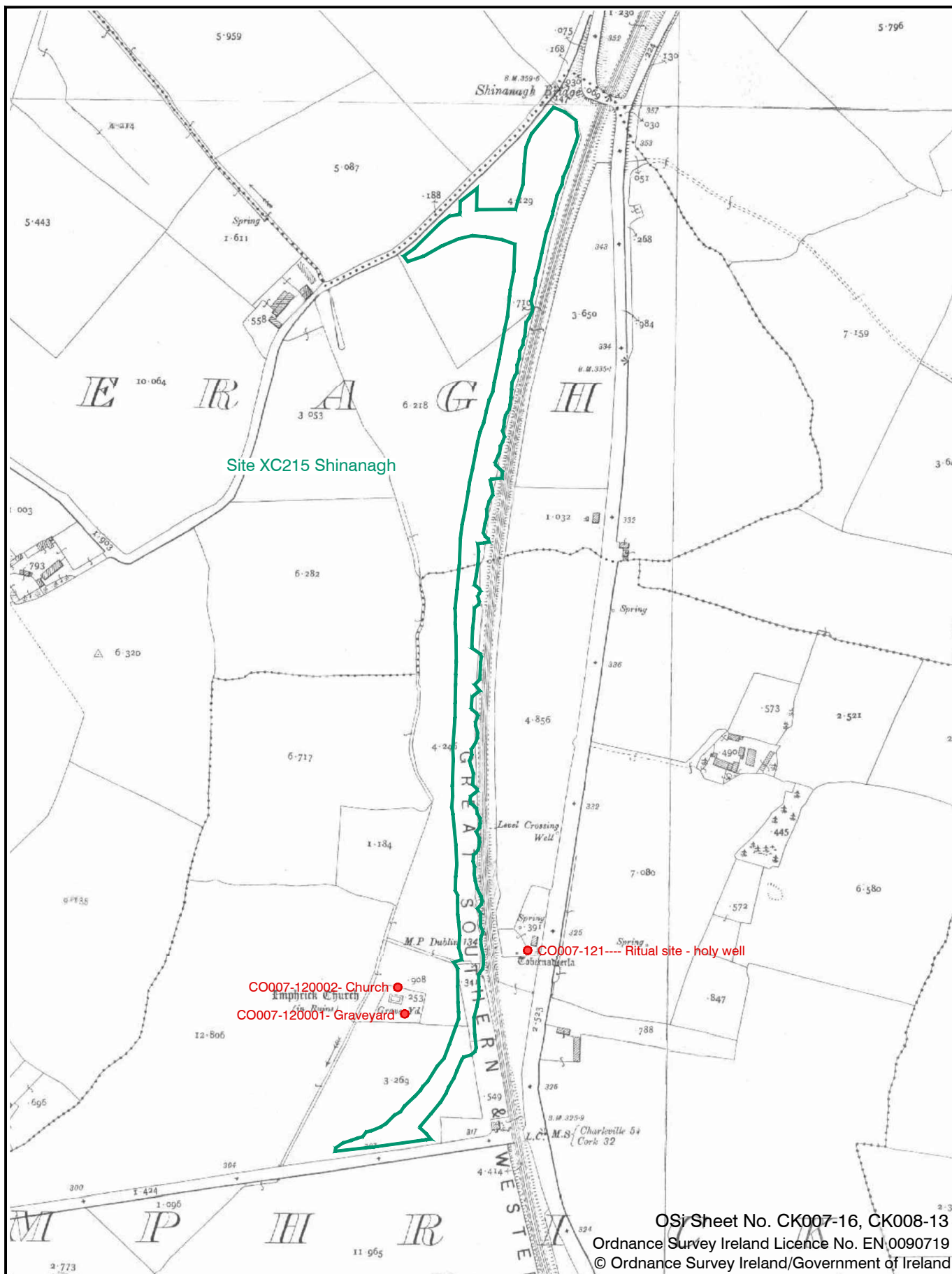

● National Monuments Service site

Archaeological Consultancy Services Unit
acsu.ie



Site: Cork Line Level Crossings Project, Co. Cork/Limerick
 Issued for: Archaeological Test Trenching Report
 Drawing number: 2058_C1004
 Date: December 2020 | Scale: 1:4,500 @A4

Figure 4: Extract from 3rd edition Ordnance Survey (OS) 25-inch map (surveyed 1903 - published 1905), showing location of site

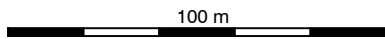
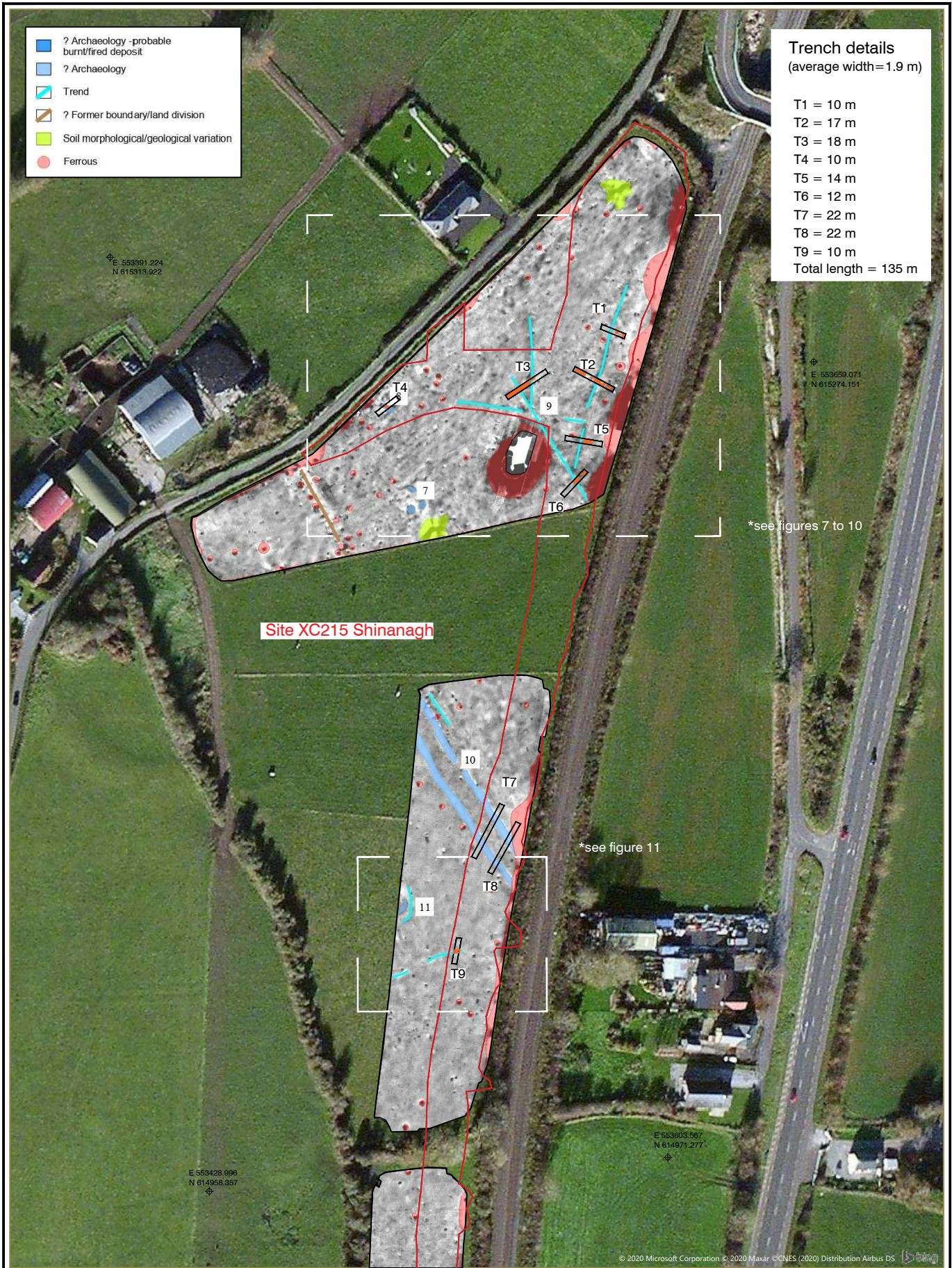

- Uncovered archaeology (Orange line)
- Excavated test trenches (Black rectangle)



Figure 5: Aerial view of site, showing geophysical survey results and location of excavated test trenches

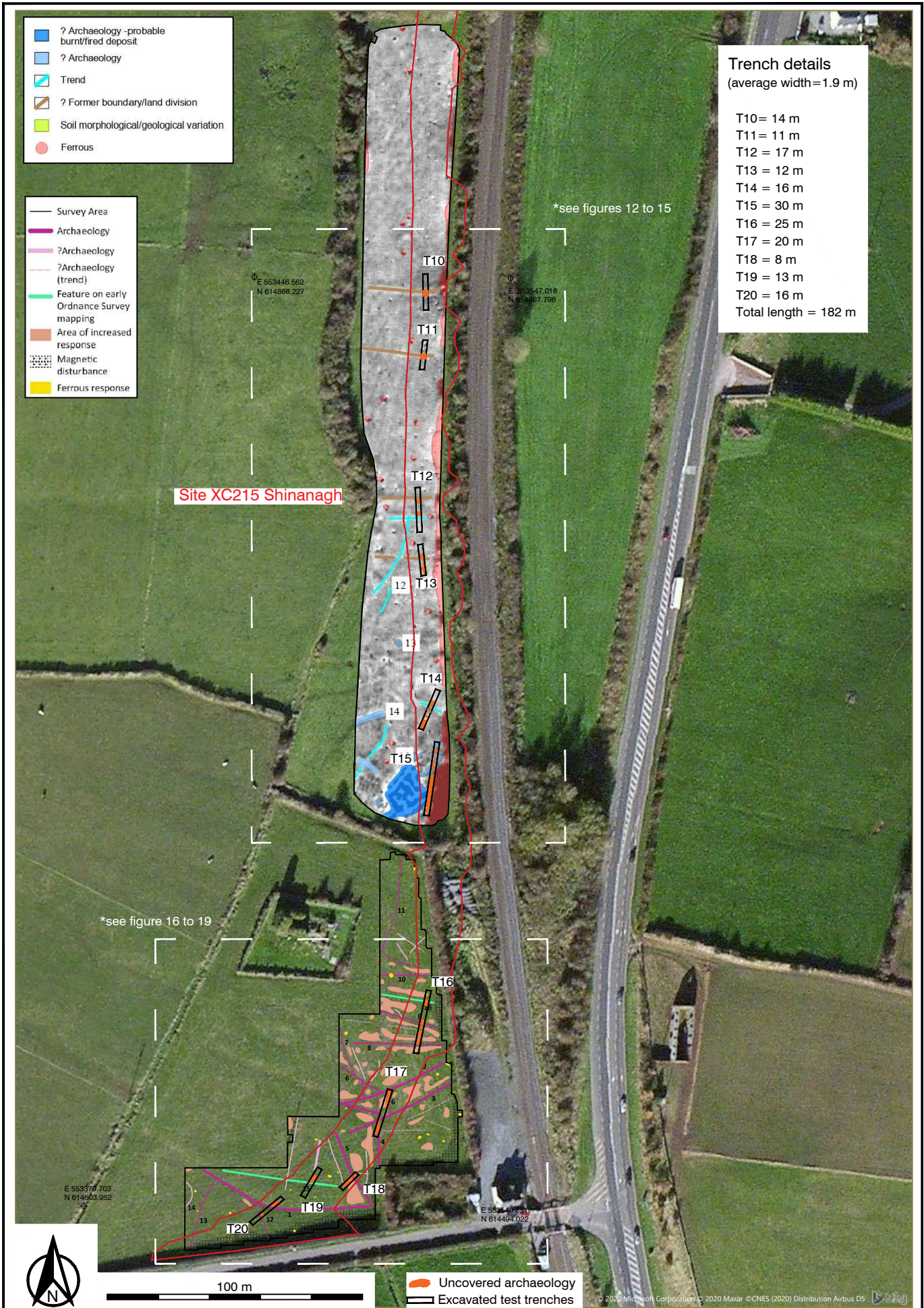
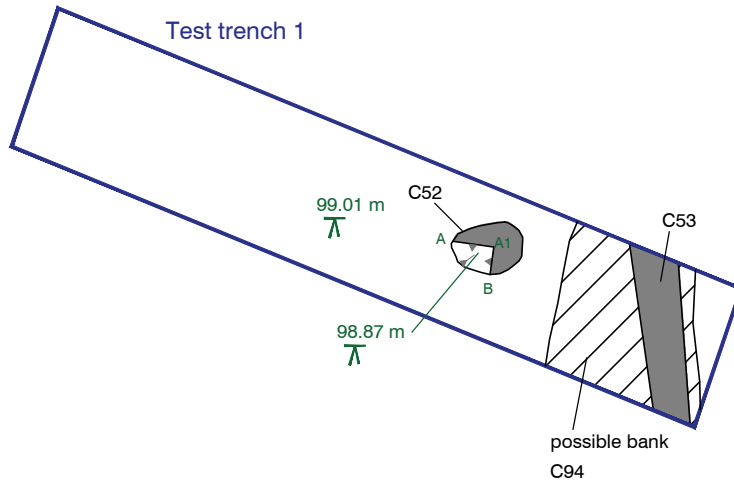
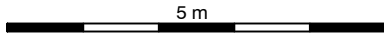

Figure 6: Aerial view of site, showing geophysical survey results and location of excavated test trenches

E 553588.8318
N 615288.5880
⊕



E 553578.6417
N 615281.0510
⊕



E 553491.5320
N 615259.7604
⊕

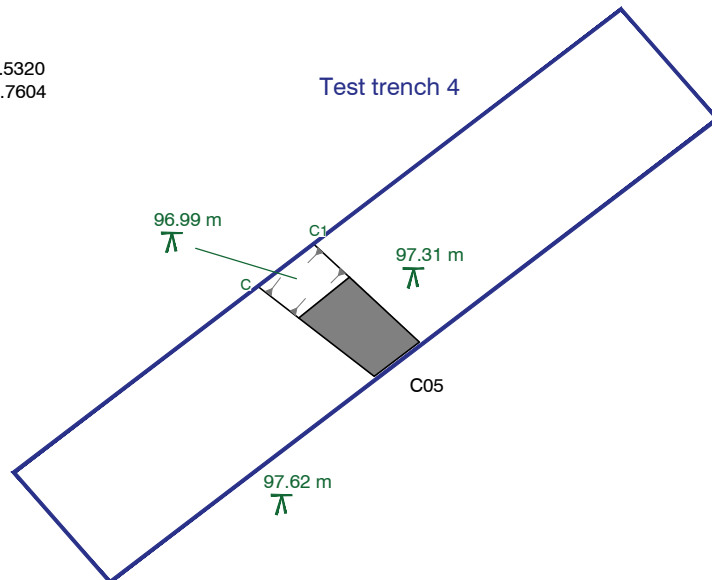

E 553502.6909
N 615252.9286
⊕

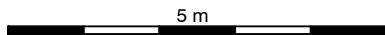

Archaeological Consultancy Services Unit
acsu.ie



Site: Cork Line Level Crossings Project, Imphrick, Co. Cork
Issued for: Archaeological Test Trenching Report
Drawing number: 2058_C1007
Date: December 2020 | Scale: 1:100 @A4

Figure 7: Details of test trenches 1 and 4

Test trench 2

E 553578.4783
N 615273.0549
⊕

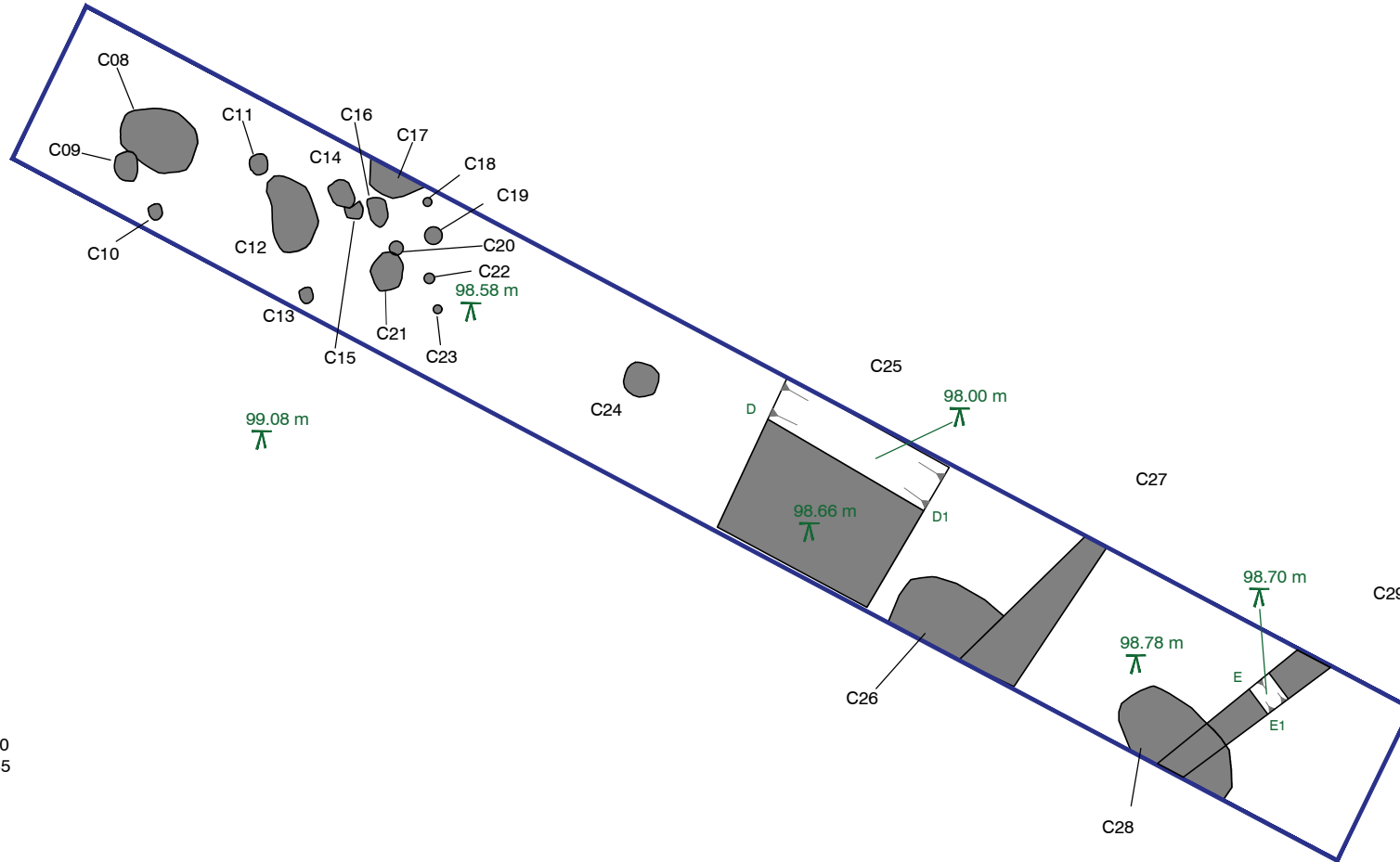

E 553566.5220
N 615263.5035
⊕

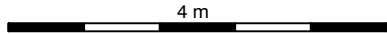

**Archaeological Consultancy
Services Unit** **acsu.ie**



Site: Cork Line Level Crossings Project, Imprick, Co. Cork	
Issued for: Archaeological Test Trenching Report	
Drawing number: 2058_C1008	
Date: December 2020	Scale: 1:80 @A4

Figure 8: Detail of test trench 2

E 553541.0238
N 615271.9138
⊕

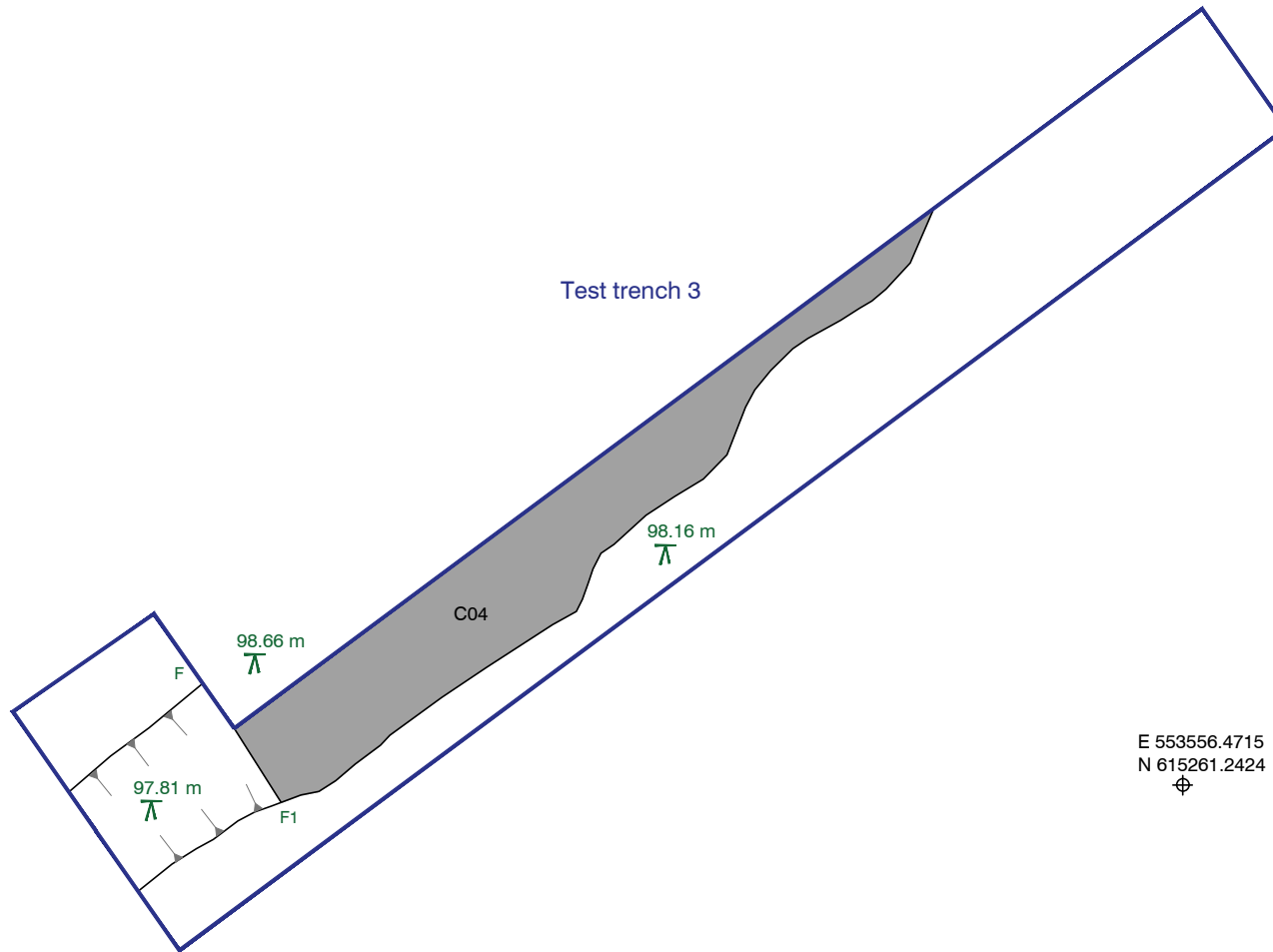

E 553556.4715
N 615261.2424
⊕

5 m



**Archaeological Consultancy
Services Unit** **acsu.ie**



Site: Cork Line Level Crossings Project, Imprick, Co. Cork	
Issued for: Archaeological Test Trenching Report	
Drawing number: 2058_C1009	
Date: December 2020	Scale: 1:100 @A4

Figure 9: Detail of test trench 3

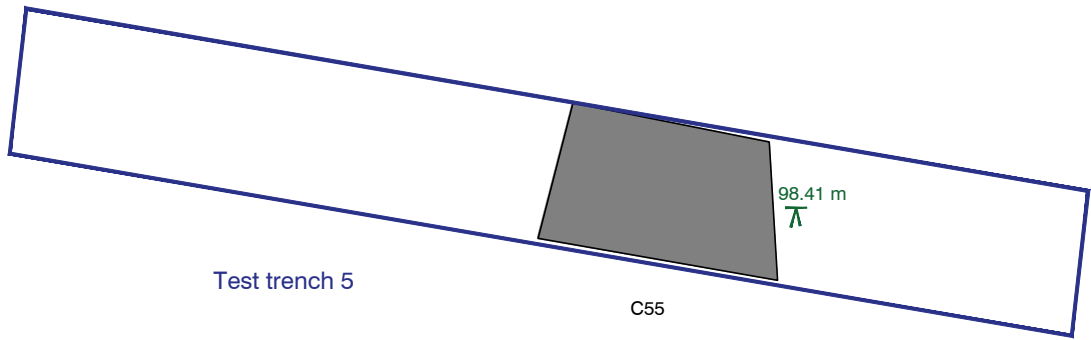

E 553564.8149
 N 615237.3899
 ⊕

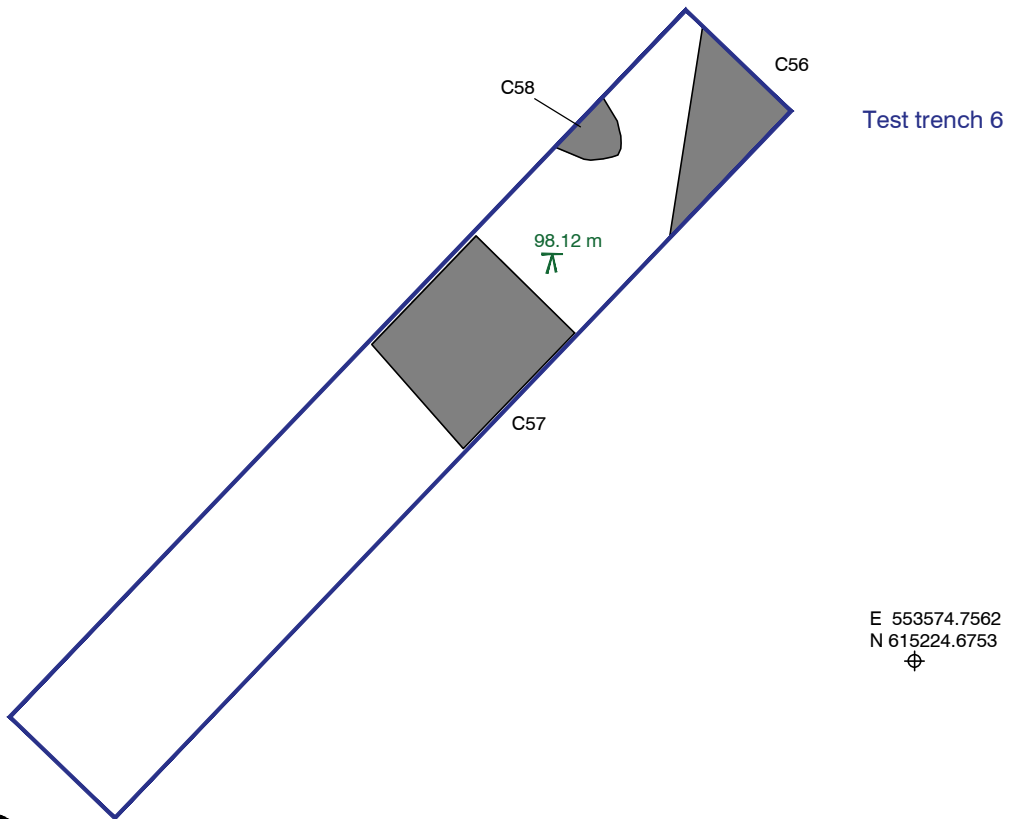

E 553574.7562
 N 615224.6753
 ⊕

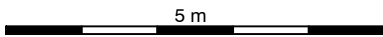

Figure 10: Detail of test trenches 5 and 6

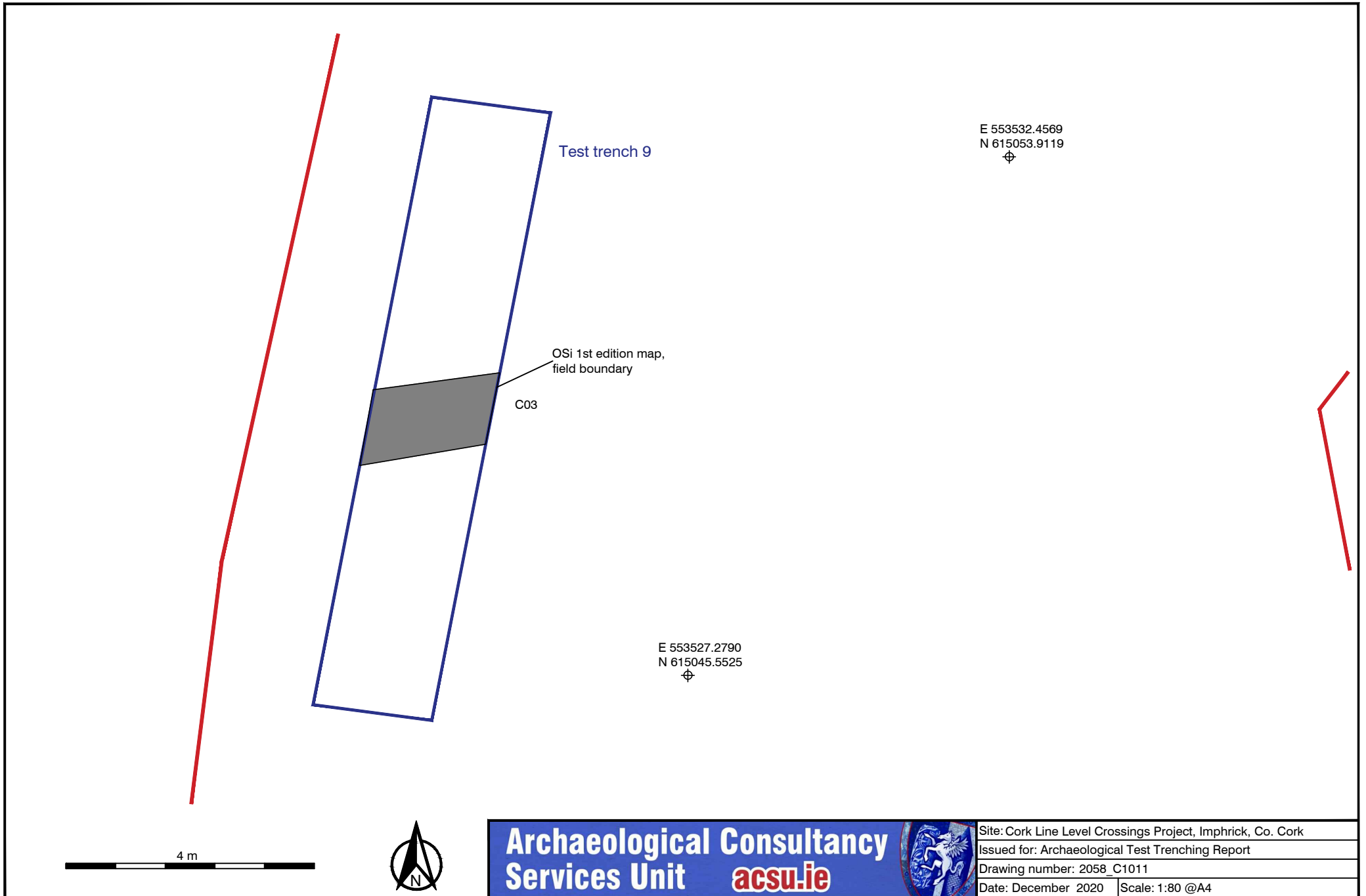

Figure 11: Detail of test trench 9

E 553501.3752
N 614865.0449
⊕

Test Trench 10

OSi 1st edition map,
field boundary

C64

Test trench 11

C63

E 553519.8729
N 614833.7906
⊕

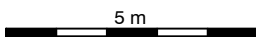
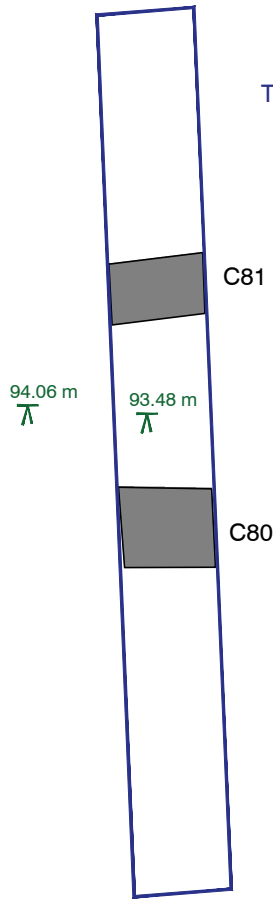

Figure 12: Detail of test trenches 10 and 11

E 553500.1520
N 614783.2605
⊕

Test trench 12



Test trench 13

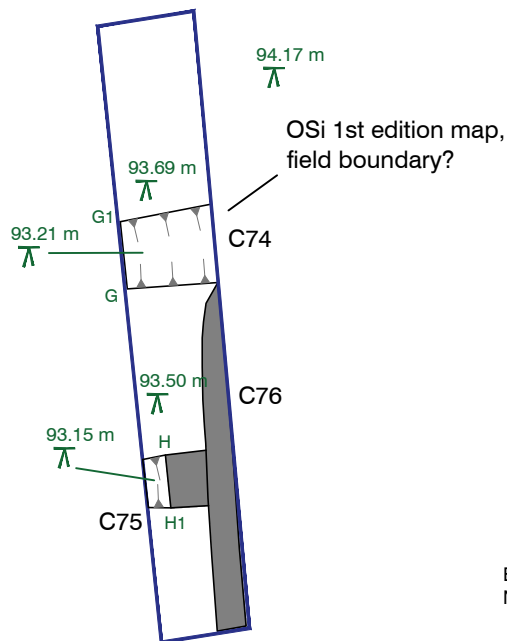

E 553519.5913
N 614751.5432
⊕

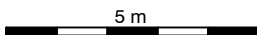

Figure 13: Detail of test trenches 12 and 13

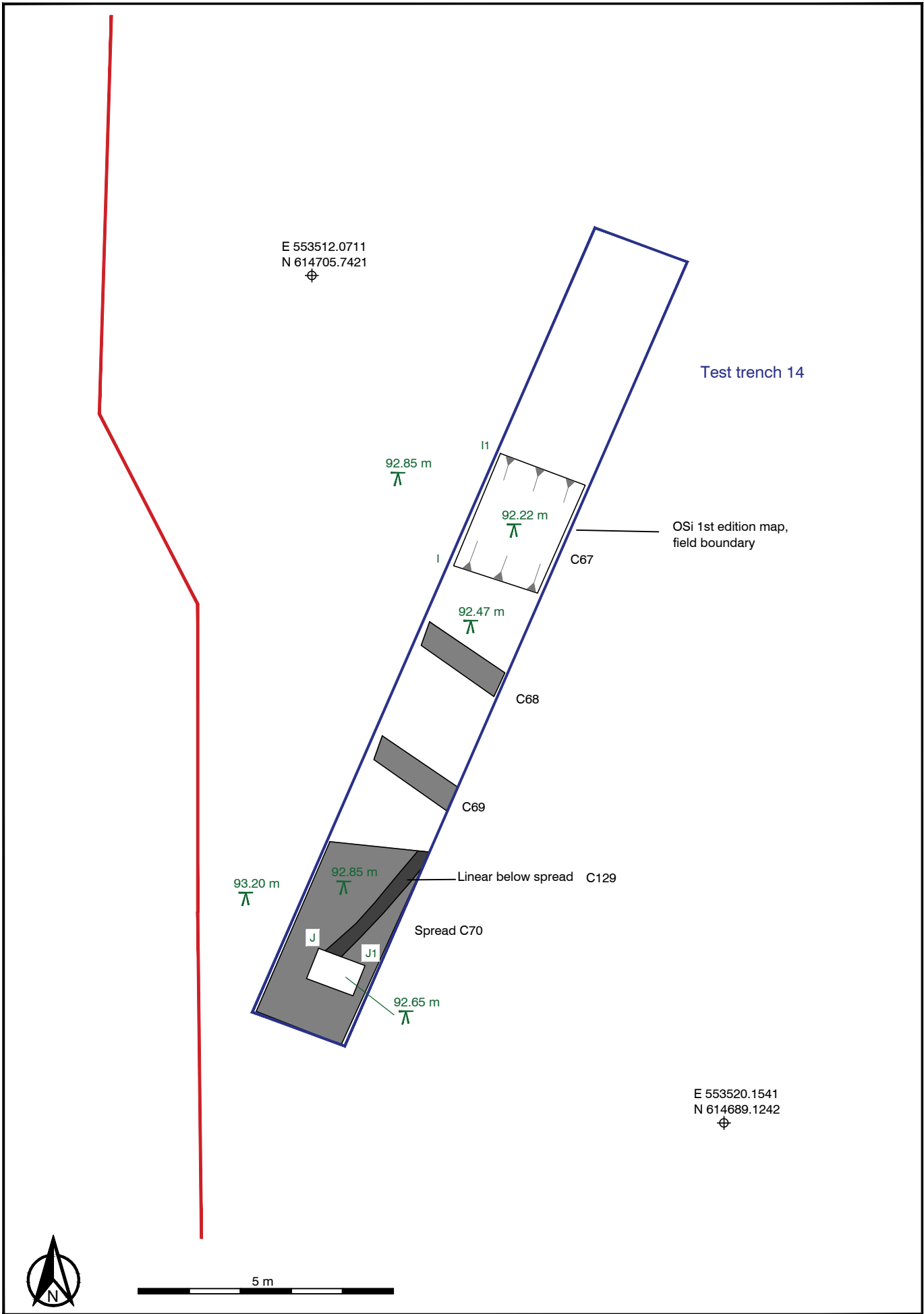
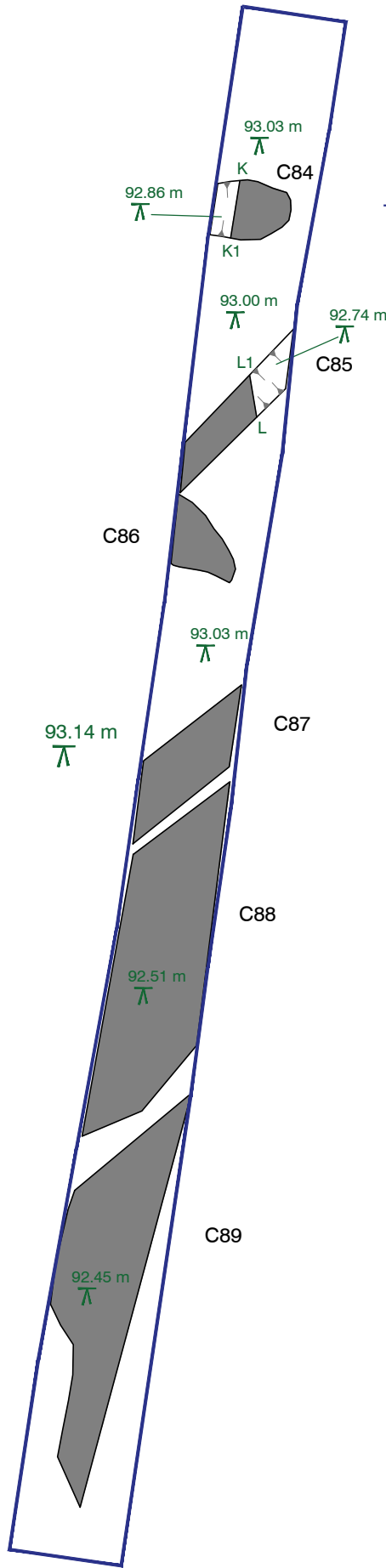

Figure 14: Detail of test trench 14

E 553507.6976
N 614681.9809
⊕



Test trench 15

E 553523.7876
N 614661.5624
⊕

6 m



Figure 15: Detail of test trench 15

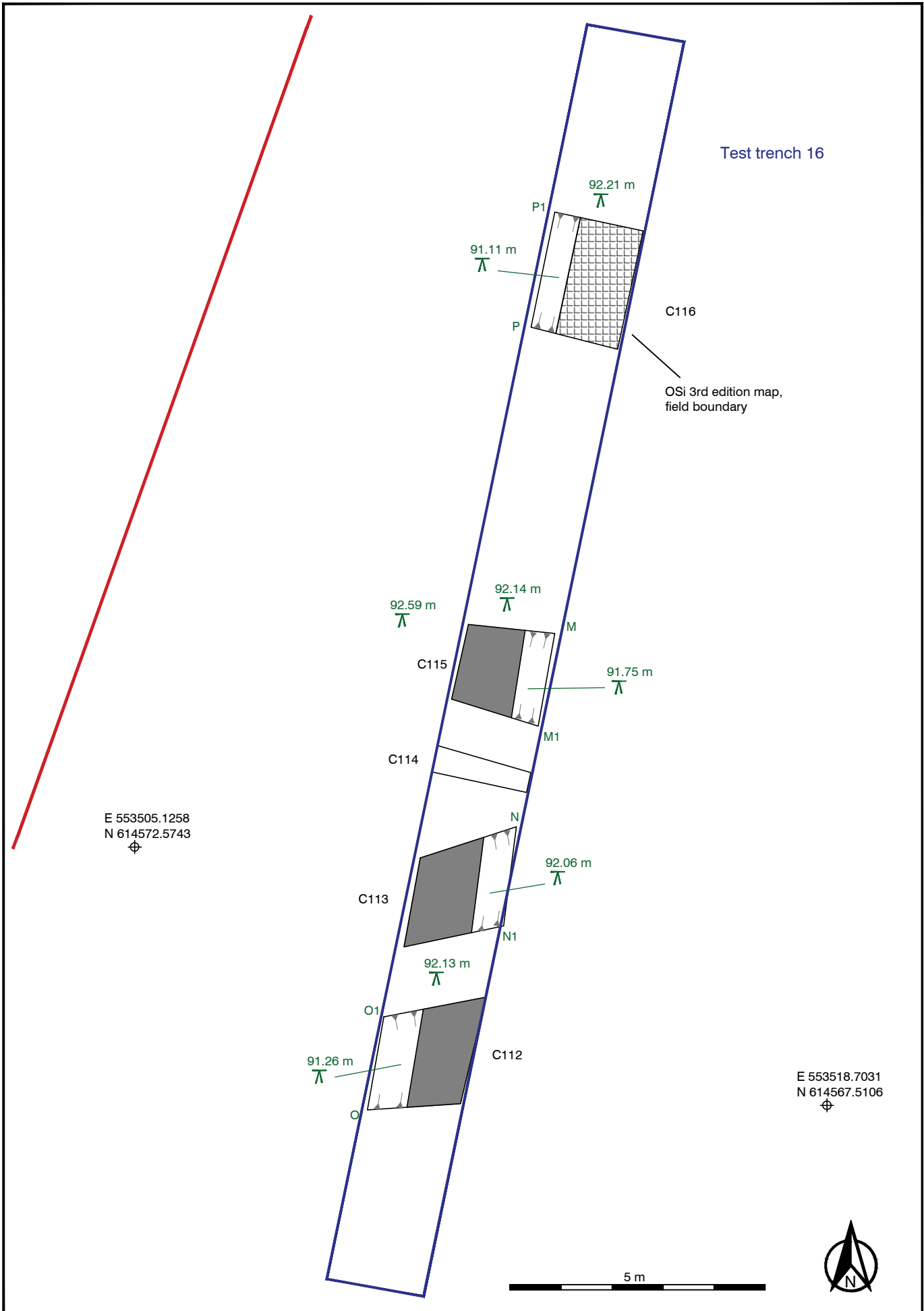

Figure 16: Detail of test trench 16

E 553502.0997
N 614551.0201
⊕

Test trench 17

OSi 1st edition map,
ditches associated
with field boundary

90.88 m
↕

Q

Q1

91.18m
↕

C121

90.79 m
↕

R

90.45 m
↕

R1

C122

E 553488.6786
N 614533.9878
⊕

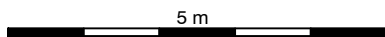

**Archaeological Consultancy
Services Unit** **acsu.ie**



Site: Cork Line Level Crossings Project, Co. Cork/Limerick

Issued for: Archaeological Test Trenching Report

Drawing number: 2058_C1017

Date: December 2020 | Scale: 1:100 @A4

Figure 17: Detail of test trench 17

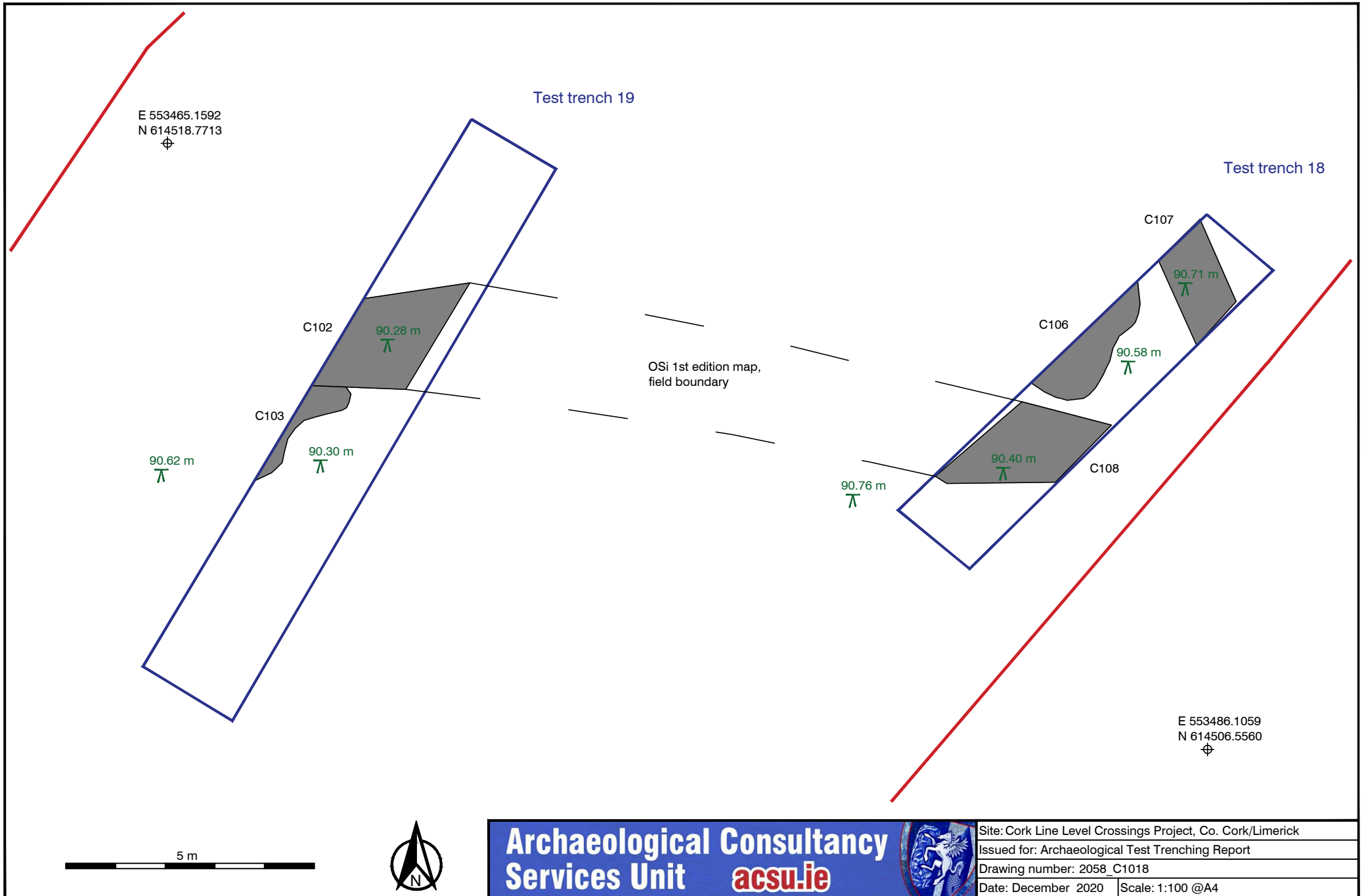

Figure 18: Detail of test trench 18 and 19

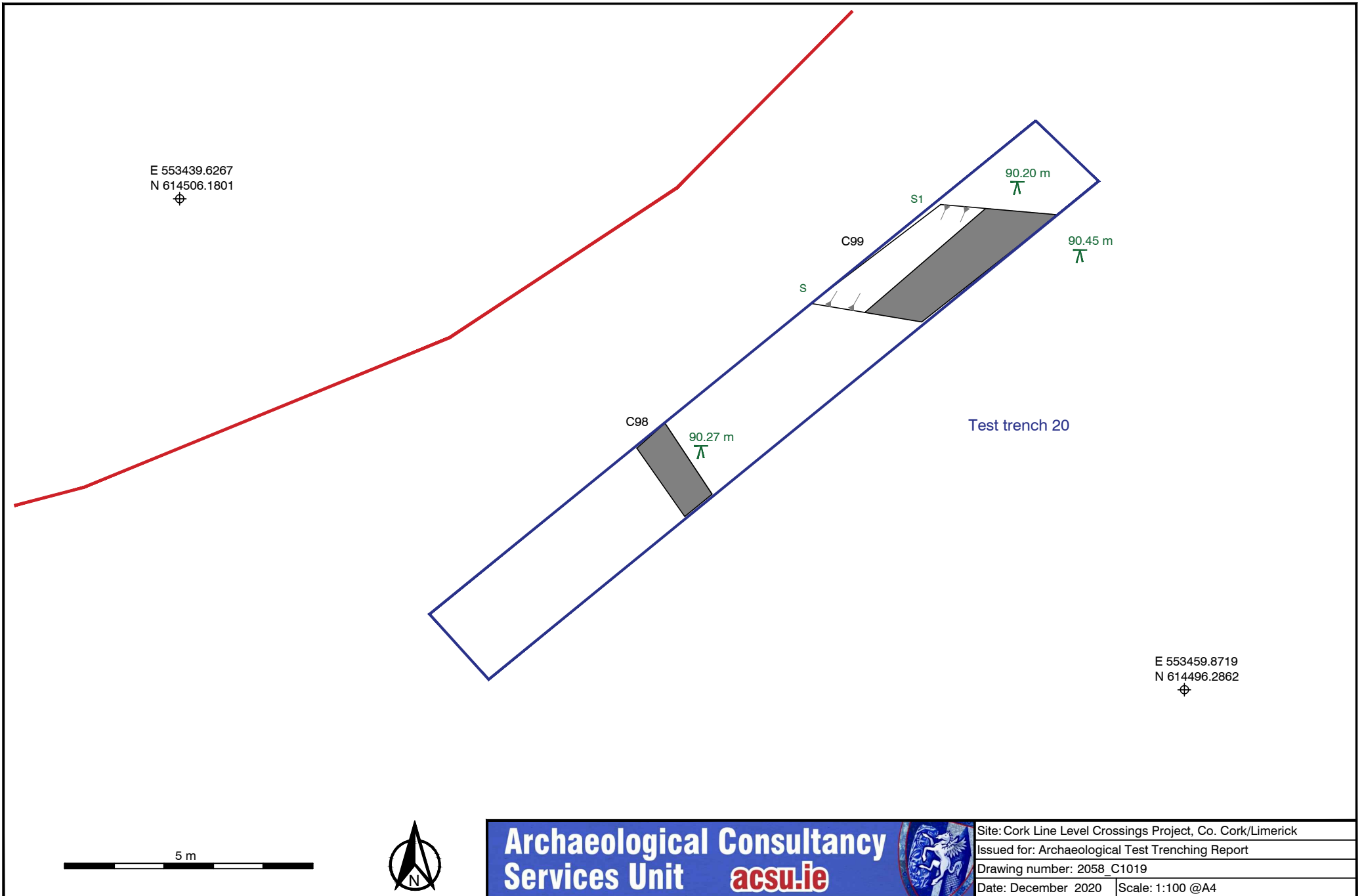
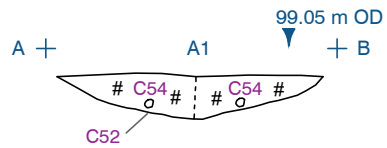
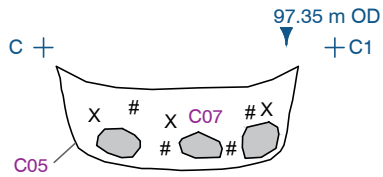

Figure 19: Detail of test trench 20

Section of pit C52 in test trench 1 (south and west facing)



Section of linear C05 in test trench 4 (southeast-facing)



Section of linear C25 in test trench 2 (northeast-facing)

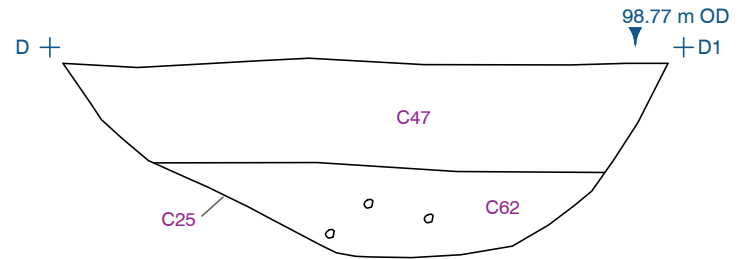

Section of furrow C29 in test trench 2 (northeast-facing)

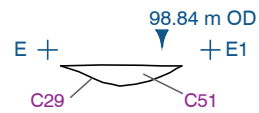

Section of linear C04 in test trench 3 (southwest-facing)

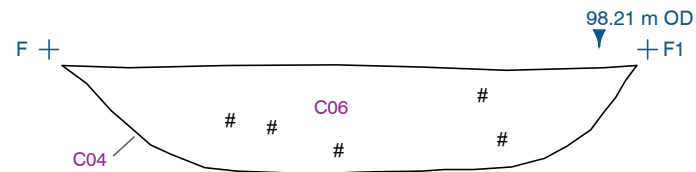

Section of linear C74 in test trench 13 (east-facing)

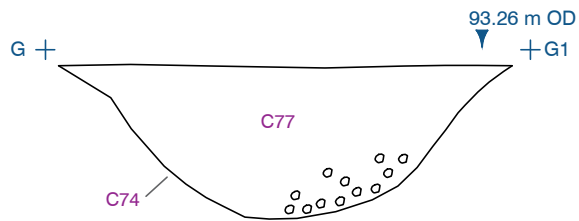

Section of linear C75 in test trench 13 (west-facing)

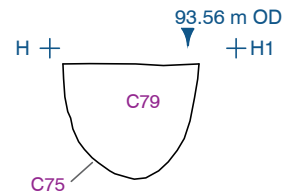

X Slag
 O Stone
 # Charcoal

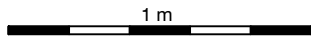

Archaeological Consultancy Services Unit
acsu.ie



Site: Cork Line Level Crossing Project, Imphrick, Co. Cork

Issued for: Archaeological Test Trenching Report

Drawing number: 2058_C1020

Date: December 2020 | Scale: 1:25 @A4

Figure 20: Sections of archaeological features uncovered in test trenches 1, 2, 3, 4 and 13

Section of linear C67 in test trench 14 (east-facing)

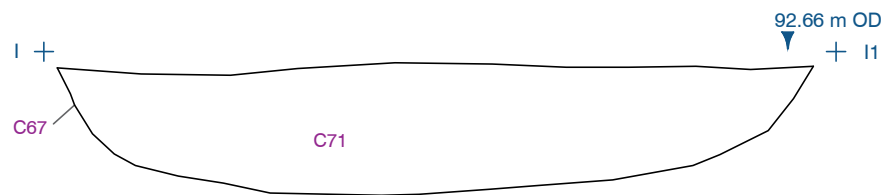

Section of spread C70 and linear C129 in test trench 14 (south-facing)

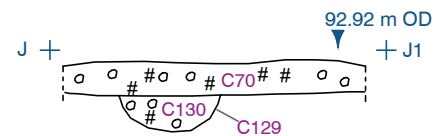

Section of pit C84 in test trench 15 (west-facing)

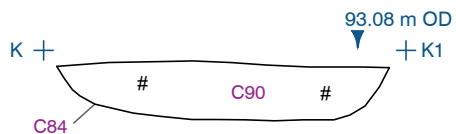

Section of linear C85 in test trench 15 (east-facing)

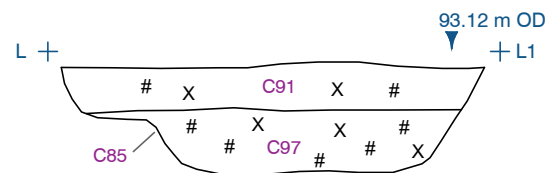

Section of linear C115 in test trench 16 (west-facing)

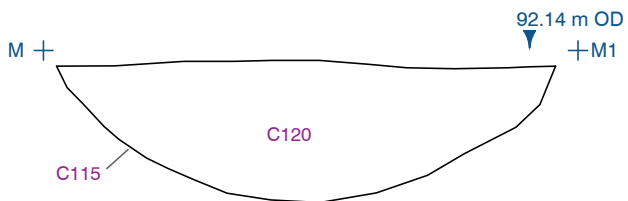

Section of linear C113 in test trench 16 (west-facing)



X Slag
 O Stone
 # Charcoal

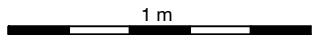

Archaeological Consultancy Services Unit
acsu.ie



Site: Cork Line Level Crossing Project, Imphrick, Co. Cork

Issued for: Archaeological Test Trenching Report

Drawing number: 2058_C1021

Date: December 2020 | Scale: 1:25 @A4

Figure 21: Sections of archaeological features uncovered in test trenches 14, 15 and 16

Section of linear C112 in test trench 16 (east-facing)

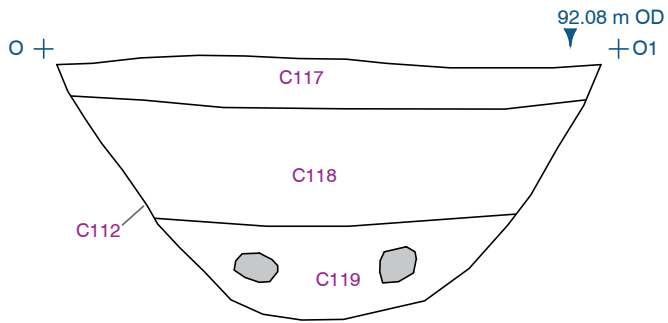

Section of modern C116 in test trench 16 (east-facing)

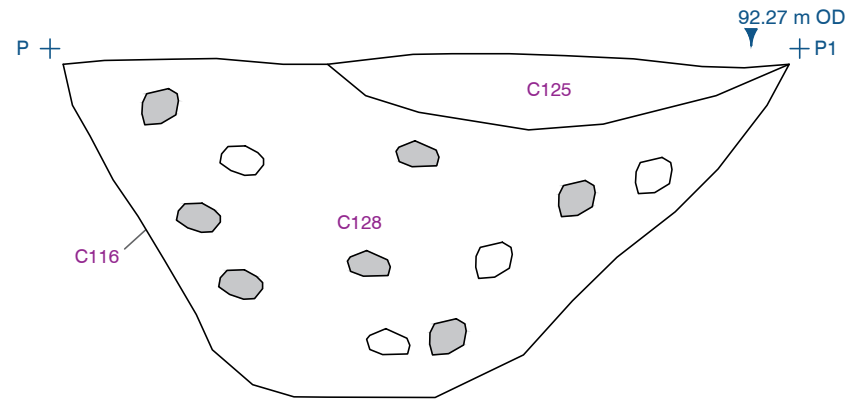

Section of linear C121 in test trench 17 (south-facing)

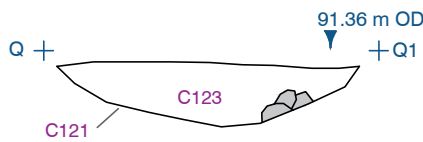

Section of linear C99 in test trench 20 (southeast-facing)

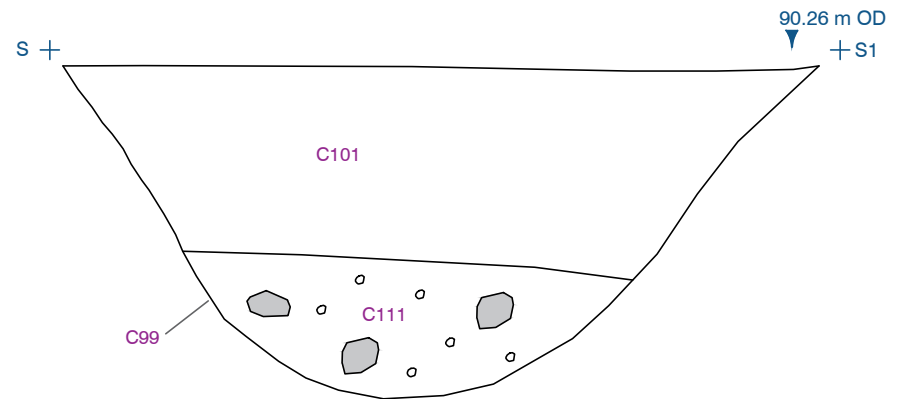

Section of linear C122 in test trench 17 (northwest-facing)

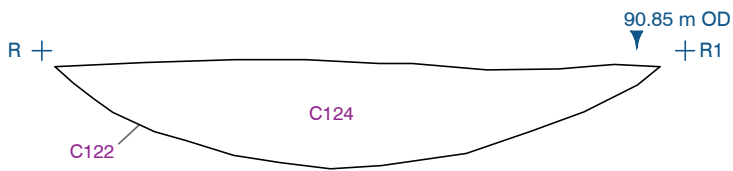

 Stone
 Charcoal

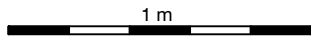

Archaeological Consultancy Services Unit
acsu.ie



Site: Cork Line Level Crossing Project, Imphrick, Co. Cork

Issued for: Archaeological Test Trenching Report

Drawing number: 2058_C1022

Date: December 2020 | Scale: 1:25 @A4

Figure 22: Sections of archaeological features uncovered in test trenches 16, 17 and 20

A



B

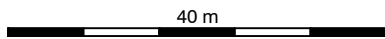
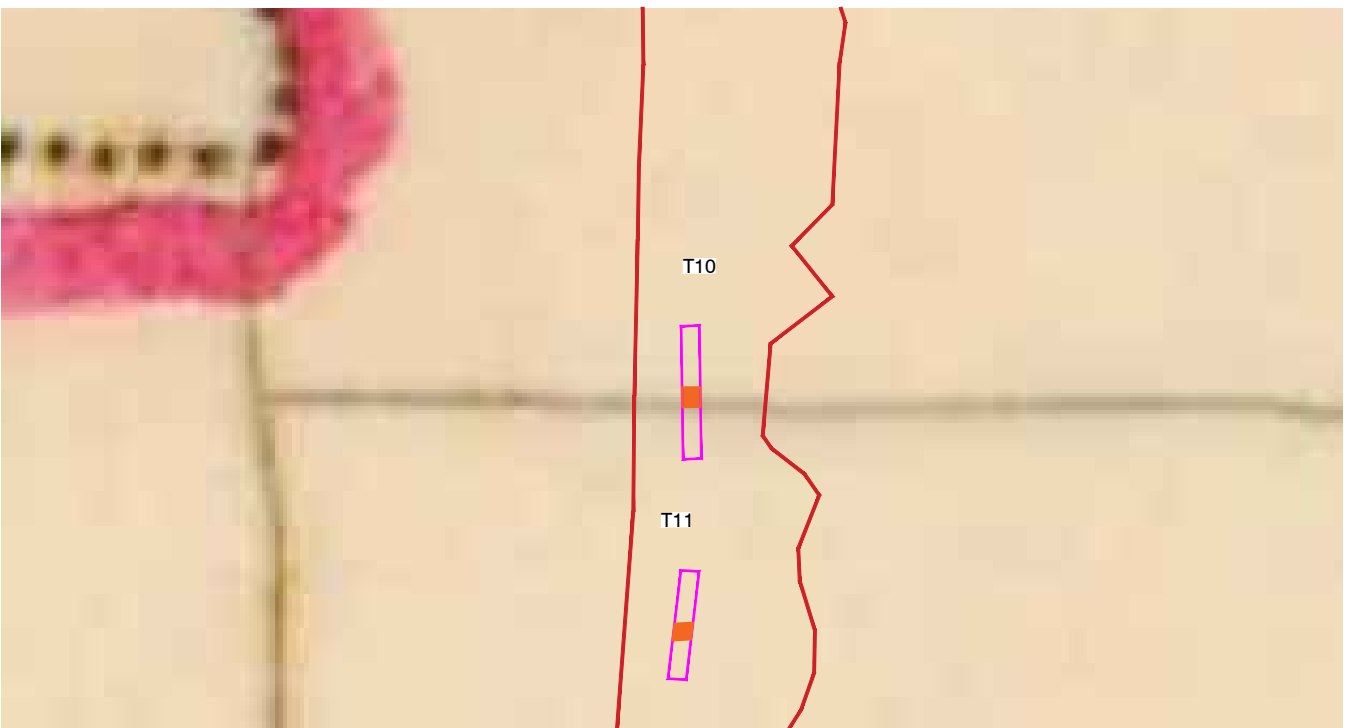

Excavated test trenches
 Uncovered archaeology

OSi Sheet No. CK007-08
 Ordnance Survey Ireland Licence No. EN 0090719
 © Ordnance Survey Ireland/Government of Ireland

**Archaeological Consultancy
 Services Unit** **acsu.ie**



Site: Cork Line Level Crossings Project, Co. Cork/Limerick	
Issued for: Archaeological Test Trenching Report	
Drawing number: 2058_C1023	
Date: December 2020	Scale: As scalebar

Figure 23: Uncovered archaeology overlaying extract from 1st edition Ordnance Survey (OS) 6-inch map (surveyed 1840 - published 1844)

A

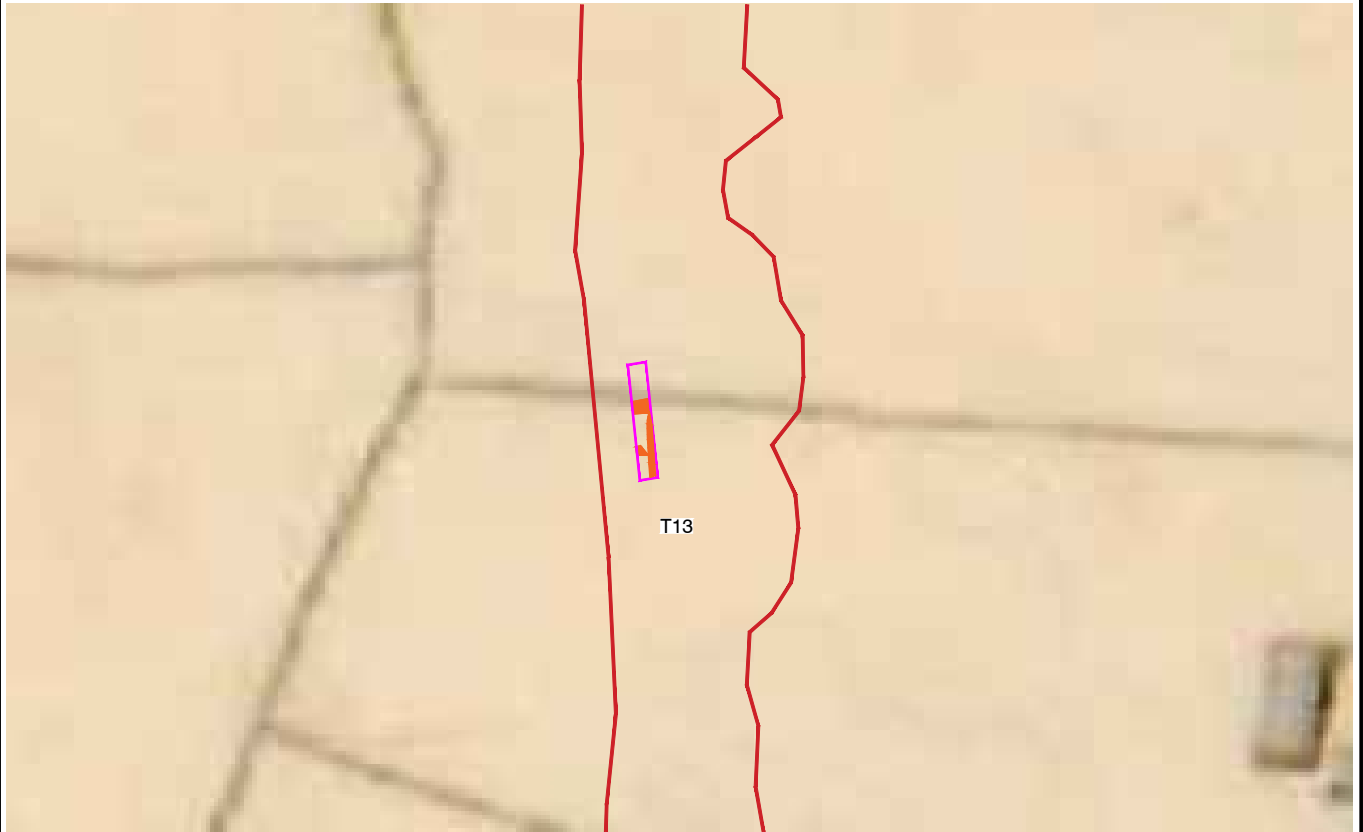

B

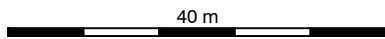

▭ Excavated test trenches
▨ Uncovered archaeology

OSi Sheet No. CK007-08
 Ordnance Survey Ireland Licence No. EN 0090719
 © Ordnance Survey Ireland/Government of Ireland

**Archaeological Consultancy
 Services Unit** **acsu.ie**



Site: Cork Line Level Crossings Project, Co. Cork/Limerick
 Issued for: Archaeological Test Trenching Report
 Drawing number: 2058_C1024
 Date: December 2020 | Scale: As scalebar

Figure 24: Uncovered archaeology overlaying extract from 1st edition Ordnance Survey (OS) 6-inch map (surveyed 1840 - published 1844)

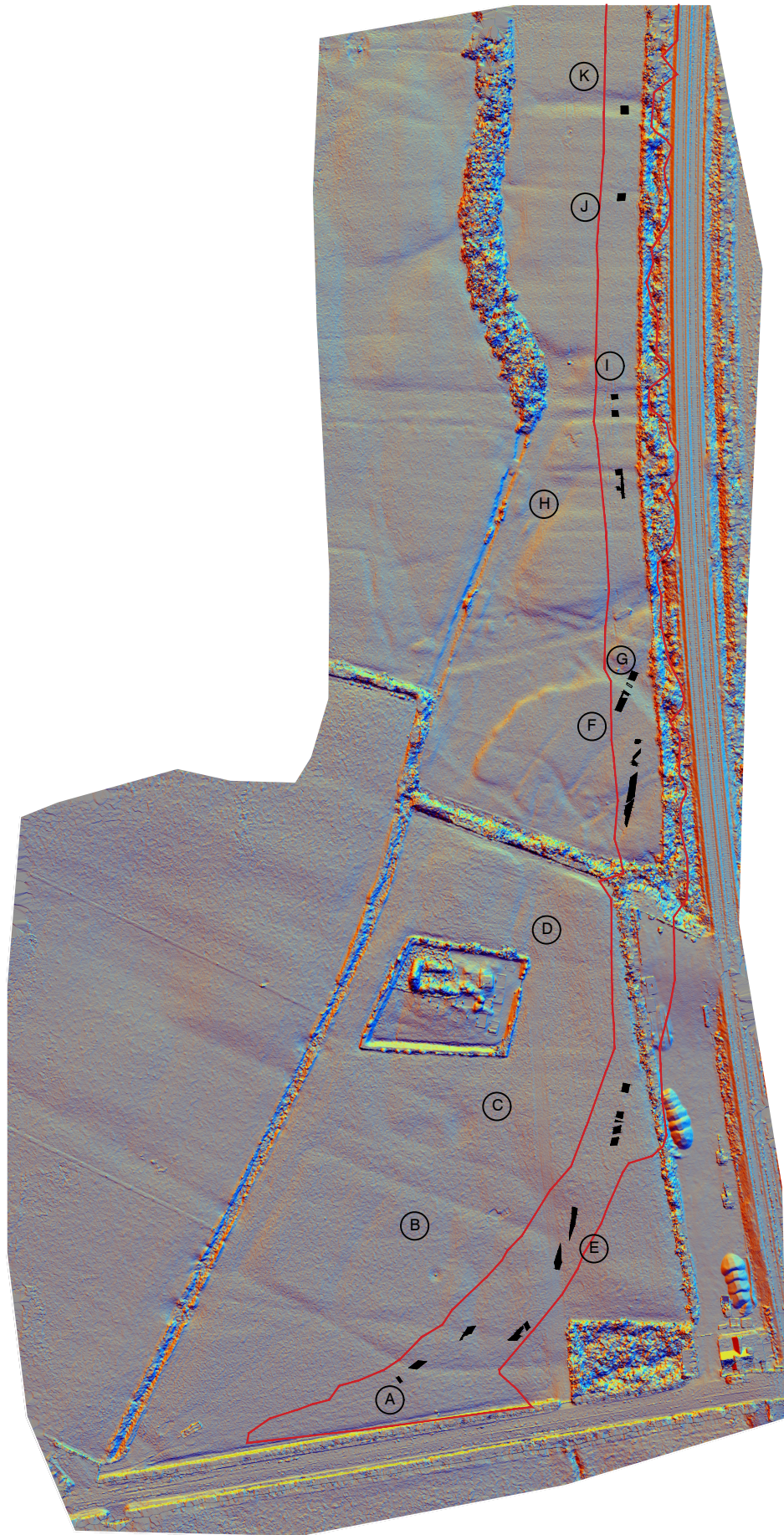

Uncovered archaeology

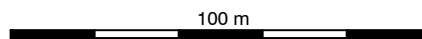

Figure 25: Uncovered archaeology overlaying multi-hillshading image



Plate 1: Test Trench 1, facing northwest



Plate 2: Test Trench 1, following removal of C95, showing C53, C52, facing east



Plate 3: Test Trench 1, pit C52, facing southwest



Plate 4: Test Trench 1, pit C52, facing southwest



Plate 5: Test Trench 2, facing southeast



Plate 6: Test Trench 2, facing southeast



Plate 7: Test Trench 2, ditch C25, facing northwest



Plate 8: Test Trench 2, ditch C25, facing northeast



Plate 9: Test Trench 3, ditch C4, facing northeast



Plate 10: Test Trench 3, ditch C4, facing northeast



Plate 11: Test Trench 4, facing northwest



Plate 12: Test Trench 4, ditch C5, facing west



Plate 13: Test Trench 4, ditch C5, facing northwest



Plate 14: Test Trench 5, facing northwest



Plate 15: Test Trench 5, ditch C56, facing northwest



Plate 16: Test Trench 6, facing northeast



Plate 17: Test Trench 6, ditch C57, facing southwest



Plate 18: Test Trench 6, pit C58 facing northwest



Plate 19: Test Trench 7, facing northeast



Plate 20: Test Trench 8, facing northeast



Plate 21: Test Trench 9, facing northeast



Plate 22: Test Trench 9, ditch C3, facing east



Plate 23: Test Trench 10, facing north



Plate 24: Test Trench 10, ditch C64, facing west



Plate 25: Test Trench 11, facing south



Plate 26: Test Trench 11, ditch C63 facing southwest



Plate 27: Test Trench 12, facing north



Plate 28: Test Trench 12, ditch C80, facing west



Plate 29: Test Trench 13, facing north



Plate 30: Test Trench 13, ditch C74, facing east



Plate 31: Test Trench 13, ditch C75, facing west



Plate 32: Test Trench 14, ditch C67, facing northwest



Plate 33: Test Trench 14, ditches C68, C69, facing southwest



Plate 34: Test Trench 14, ditch C67 facing west



Plate 35: Test Trench 14, spread C70 and linear C129, facing northeast



Plate 36: Test Trench 15, C84-C86, facing southwest



Plate 37: Test Trench 15, linear C87, spreads C88, C89, facing south



Plate 38: Test Trench 15, ditch C85 and pit C84, facing north



Plate 39: Test Trench 15, ditch C85, facing east



Plate 40: Test Trench 15, pit C84, facing west



Plate 41: Test Trench 16, facing northeast



Plate 42: Test Trench 16, ditch C116, facing west



Plate 43: Test Trench 16, ditch C112, facing west



Plate 44: Test Trench 16, ditch C113, facing southeast



Plate 45: Test Trench 16, ditch C115, facing west



Plate 46: Test Trench 17, facing northeast



Plate 47: Test Trench 17, ditch C121, facing north



Plate 48: Test Trench 17, ditch C122, facing north



Plate 49: Test Trench 18, ditch C107, facing southwest



Plate 50: Test Trench 18, ditch C107, facing northeast



Plate 51: Test Trench 18, ditch C108, facing southwest



Plate 52: Test Trench 19, ditch C102, spread C103, facing north



Plate 53: Test Trench 20, ditch C99, facing southwest



Plate 54 Test Trench 20, ditch C99, facing northeast



Plate 55: Test Trench 20, ditch C99, facing northwest



Plate 56: Test Trench 20, ditch C98, facing southwest